

345D L

Hydraulic Excavator



Engine

Engine Model	Cat® C13 ACERT™	
Net Flywheel Power	283 kW	380 hp

Weights

Operating Weight – Long Undercarriage	45 375 kg	100,040 lb
Operating Weight – Long Variable	49 265 kg	108,610 lb

- 6.9 m (22'8") HD Reach Boom, R3.9m (12'10") Stick, 1219 mm (48") GP-C Bucket, 750 mm (30") TG Track Shoes, Long Undercarriage

345D L Hydraulic Excavator

The 345D L hydraulic excavator's high performance and rugged durability combine to maximize your productivity.

C13 Engine with ACERT™ Technology

ACERT™ Technology works at the point of combustion to optimize engine performance and provide low exhaust emissions to meet U.S. EPA Tier 3 and EU Stage IIIA emission regulations, with exceptional performance capabilities and proven reliability. **pg. 4**

Hydraulics

The hydraulic system has been designed to provide reliability and outstanding controllability. An optional Tool Control System provides enhanced flexibility. **pg. 5**

Operator Station

Provides maximum space, excellent visibility and easy access to all switches. The monitor is a full-color graphical display that allows the operator to understand the machine information easily. Overall, the cab provides a comfortable environment for the operator. **pg. 6**

Work Tools

A variety of work tools, including buckets, couplers, hammers, and shears are available through Cat® Work Tools. **pg. 11**

Versatility

Caterpillar offers a wide variety of optional and factory-installed attachments to enhance performance and improve job site management. **pg. 12**

Complete Customer Support

Your Cat dealer offers a wide range of services – from assistance with configuring your machine to best match your application to customer support agreements to meet your maintenance needs. Repair Option Programs guarantee the cost of repairs up front and help you to avoid unscheduled repairs. **pg. 15**

Outstanding performance. Excellent control, high stick and bucket forces, impressive lift capacity, simplified service and a comfortable operator station to increase your productivity and lower operating costs.



Undercarriage

Cat designed excavator undercarriage is stable, durable and low maintenance. Available in Fixed, Variable and Wide Variable gauge configurations to meet lift capacity and bucket size needs. **pg. 8**

Structures

Caterpillar® design and manufacturing techniques assure outstanding durability and service life from these important components. **pg. 9**

Boom, Sticks and Attachments

Built for good performance and long service life, Cat booms and sticks are box-section structures with thick multi-plate fabrications to resist high stress. Three lengths of booms and five types of sticks are available, offering a range of configurations suitable for a wide variety of applications and conditions. **pg. 10**

AccuGrade™ Grade Control System for Hydraulic Excavators

The AccuGrade System helps to move material right the first time, reduces costs and increases material utilization. The system improves operator skills, helping with labor requirements and improves safety on the job site. **pg. 13**

Service and Maintenance

Fast, easy service has been designed in with extended service intervals, advanced filtration, convenient filter access and user-friendly electronic diagnostics for increased productivity and reduced maintenance costs. **pg. 14**



C13 Engine with ACERT™ Technology

Built for power, reliability, economy and low emissions.



Performance. The 345D L, equipped with the C13 with ACERT Technology, meets the U.S. EPA Tier 3 emissions while providing 10% more horsepower compared to the 345C L. The building blocks of ACERT Technology are fuel delivery, air management, and electronic control – providing better fuel economy and reduced wear.

Emissions. ACERT Technology is a differentiated technology that reduces emissions at the point of combustion. The technology capitalizes on Caterpillar's proven leadership in three core engine systems: fuel, air and electronics.

Fuel System. The Cat C13 features electronic controls that govern the mechanically actuated unit fuel injection (MEUI) system. MEUI provides the high-pressure required to help reduce particulate emissions and deliver better fuel economy through finer fuel atomization and more complete combustion.

Controllers. The mechanically actuated unit injection system features a high-pressure fuel injection system, proven to significantly reduce fuel consumption and particulate emission. Electronic Unit Injection (EUI) produces high-pressure and affords the integration of electronics with fewer components. The modular design of the electronic control system allows greater update, flexibility, improves serviceability and lowers repair costs.

ADEM™ A4 Engine Controller.

The ADEM™ A4 electronic control module manages fuel delivery to get the best performance per liter or gallon of fuel used. The engine management system provides flexible fuel mapping, allowing the engine to respond quickly to varying application needs. It tracks engine and machine conditions while keeping the engine operating at peak efficiency.

Turbocharger. The Cat C13 uses a wastegate turbocharger for improved performance.

- The wastegate valve controls excessive engine boost pressure by allowing exhaust to bypass the exhaust-side turbine.
- The wastegate also reduces turbine wear in high RPM, low load conditions and optimizes air and fuel delivery for peak engine performance.
- The turbocharger increases the density of the air, enabling the engine to produce more power with few effects from altitude.

Low Sound and Vibration Levels.

The engine mounts are rubber-isolating mounts matched with the engine package to provide optimum sound and vibration reduction. Further noise reduction has been achieved through design changes to the isolated top cover, oil pan, multiple injection strategy, insulated timing cover and sculpted crankcase.

Air Cleaner. The radial seal air filter features a double-layered filter core for more efficient filtration and is located in a compartment behind the cab. A warning is displayed on the monitor when dust accumulates above a preset level.

Cooling System. The 345D L layout completely separates the cooling system from the engine compartment. The cooling fan is hydraulically driven with variable speed control based on the ambient temperature, coolant temperature, and hydraulic oil temperature. This unique feature assists in the management of engine power and improves noise efficiency while providing optimized cooling.

Cold Weather Starting Kit. The optional kit includes two additional batteries, heavy-duty battery cables, and the ether starting aid. With this kit, the 345D L has the capability to start at -32°C (-25.6°F).

Hydraulics

Cat® hydraulics deliver power and precise control to keep material moving.

Pilot System. The pilot pump is independent from the main pumps and controls the front linkage, swing and travel operations. The pilot control valve operation is proportional to control lever movement, delivering outstanding controllability.

Component Layout. The component location and hydraulic system design provide the highest level of system efficiency. The main pumps, control valve and hydraulic tank are located as close to each other as possible. This design makes it possible to use shorter tubes and lines between components, reducing friction losses and pressure drops.

Heavy Lift Standard. The operator can select the heavy lift mode at the push of a button to boost lifting capability and provide improved controllability of heavy loads.

Hydraulic Cross-Sensing System. The hydraulic cross sensing system utilizes each of two hydraulic pumps to 100 percent of engine power under all operating conditions. This improves productivity with faster implement speeds and quicker, stronger pivot turns.

Boom and Stick Regeneration Circuits. A hydraulically operated stick regeneration circuit saves energy and improves multi-function performance during the stick-in operation. New on the 345D L, the boom regeneration circuit is operated electrically, and this system is managed by the machine ECM. The system improves cycle times and fuel efficiency, increasing your productivity and reducing operating costs.



Boom and Swing Priority. The hydraulic system on the 345D L provides automatic priority function for boom-up and swing operations eliminating the need for work mode buttons. When the boom or swing lever is activated, the system automatically assigns priority based on operator demand.

Hydraulic Cylinder Snubbers. Snubbers are located at the rod-end of the boom cylinders and both ends of the stick cylinders to cushion shocks while reducing sound levels and extending component life.

Operator Station

Designed for simple, easy operation, the 345D L allows the operator to focus on production.



Cab Design. The workstation is spacious, quiet and comfortable, assuring high productivity during a long work day. The air conditioner and attachment switches are conveniently located on the right-hand wall, and the key switch and throttle dial are on the right-hand console. The monitor is easy to see with excellent visibility.

Standard Cab Equipment. To enhance operator comfort and productivity, the cab includes a lighter, drink holder, coat hook, service meter, literature holder, magazine rack and storage compartment.



Monitor Display Screen. The compact, full color 400x234 pixels Liquid Crystal Display (LCD), displays machine maintenance, diagnostic and prognostic information, in twenty-seven different languages. The keypad allows the operator to select machine operation conditions and to set view preferences. The Master Caution Lamp blinks ON and OFF when one of these critical conditions occur:

- Engine oil pressure low
- Coolant temperature high
- Hydraulic oil temperature high

Under the normal condition or the default condition, the monitor display screen is divided into four areas: clock and throttle dial area, gauge area, event display area and multi-information display area.

Clock and Throttle Dial Area. The clock, throttle dial position and green gas-station icon are displayed on the monitor screen.

Gauge Area. Three analog gauges, fuel level, hydraulic oil temperature and coolant temperature, are displayed on the monitor screen.

Event Display Area. Machine information is displayed on the monitor screen with the icon and language.

Multi-information Display Area.

This area is reserved for displaying information that is convenient for the operator. The “CAT” logo is displayed when no information is available to be displayed.



Console. The consoles feature a simple, functional design to reduce operator fatigue, ease of switch operation and excellent visibility. Both consoles have attached armrests with height adjustments.

Travel Controls. The 345D L uses pilot operated control levers, positioned so the operator can operate with arms on the armrests. The vertical stroke is longer than the horizontal stroke, reducing operator fatigue. The control lever grips are shaped to fit into the operator’s hands. The horn switch and one-touch low idle switch are positioned on the left and right grip.

Hydraulic Activation Control Lever.

For added safety, this lever must be in the operate position to activate the machine control functions.

Seat. A high-back, heated, air-suspension seat is now standard on the 345D L.

The seat allows a variety of adjustments to suit the operator’s size and weight and provides a comfortable working environment. Wide adjustable armrests and a retractable seatbelt are also included.

Climate Control. Positive filtered ventilation with a pressurized cab comes standard on the 345D L. Fresh air or re-circulated air can be selected with a switch on the left console.

Cab Exterior. The exterior design uses thick steel tubing along the bottom perimeter of the cab, improving the resistance of fatigue and vibration. This design allows the FOGS to be bolted directly to the cab, at the factory or as an attachment later, enabling the machine to meet specifications and job site requirements.

Cab Mounts. The cab shell is attached to the frame with viscous rubber cab mounts, which dampen vibrations and sound levels while enhancing operator comfort.

Windows. All glass is affixed directly to the cab, eliminating window frames and providing excellent visibility. The upper front windshield opens, closes and stores on the roof above the operator with a one-touch action release system.

Wipers. Pillar-mounted wipers increase the operator’s viewing area and offer continuous and intermittent modes.

Skylight. An enlarged skylight with sunshade provides excellent visibility and good ventilation.

Undercarriage

Durable undercarriage absorbs stresses and provides excellent stability.



Undercarriage Options. Track with Positive Pin Retention 2 (PPR2) and cast idlers are available as attachments on the 345D L. The PPR2 prevents loosening of the track pin from the track link and the cast idler is designed for extended life. Both options are ideal for extreme applications or those that require a large amount of travel.

Travel Motors. Two-speed axial piston hydraulic motors provide the 345D L drive power and speed selection. When the high-speed position is selected, the machine automatically changes between computer-controlled high and low speeds depending on drawbar-pull requirements.

Straight-line Travel Circuit. The straight-line travel circuit is incorporated into the hydraulic system, which maintains low-speed, straight-line travel, even when operating the front linkage.

Final Drive. The final drives are a three-stage planetary reduction. This design results in a complete drive/brake unit that is compact and delivers excellent performance and reliability.

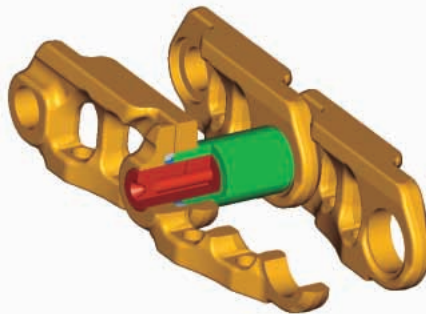

Track. The 345D L comes standard with a grease lubricated track called GLT4. The track links are assembled and sealed with grease to decrease internal bushing wear, reduce travel noise, and lower operating costs by extending service life. The track link for the 345D L has been re-designed to avoid the concentration of stresses and improve durability and reliability.

Track Guards. The idler guard and bolt-on center guard are standard equipment. They help maintain track alignment while traveling or working on slopes. For applications that require additional track protection or alignment, optional guards are available.

Structures

The 345D L structural components are the backbone of the machine's durability.

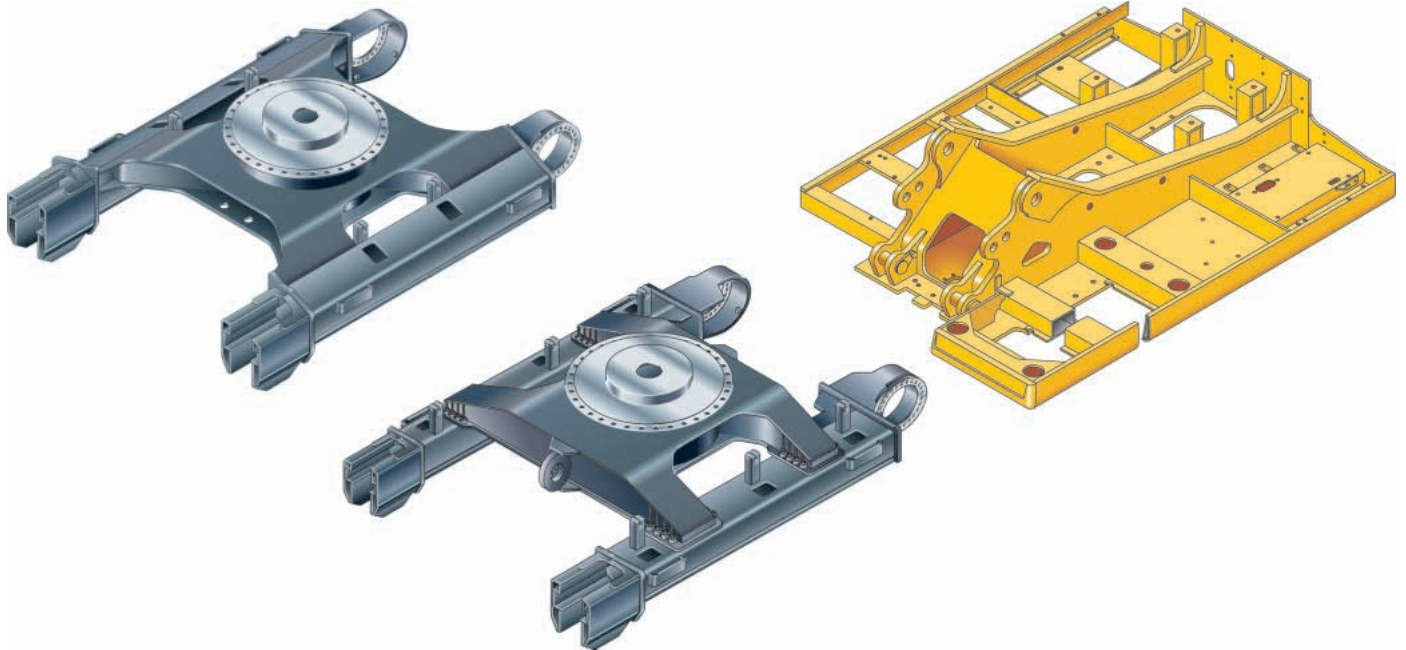

Carbody. The 345D L has three undercarriage options to meet regional transportation requirements and application needs.

- Fixed gauge for narrow transport and weight sensitive areas.
- Variable gauge for increased track and ground clearance and over-side lift.
- Wide variable gauge, provided as an attachment to the variable gauge machine, provides a significant increase in over-side lift with the capability for handling larger buckets.

The carbody utilizes a columnless design that allows the swing bearing to be directly mounted on the top plate for excellent rigidity and strength.

Upper Frame. The rugged main frame is designed for maximum durability. Robot welding is used for consistent, high-quality welds. The main channels are box sections connected by a large diameter tube in the boom foot area to improve rigidity and strength. The outer frame utilizes curved side rails for rigidity against bending and torsional loads.

Counterweights. The 345D L has several counterweight options to best match the machine to your application. Counterweight removal device is available for the 7.6 mt (16,760 lb) and 8.7 mt (19,180 lb) counterweights to facilitate transport when needed.

Track Roller Frame. Fixed Gauge Undercarriage

- Uses a press-formed, pentagonal section for the track frame that is robot-welded for weld consistency and quality. The track frame has been designed so that the top of the track frame has a steep angle to help prevent accumulation of mud and debris.

Variable Gauge Undercarriage

- The track roller frame is made of thick steel plate that is bent into a U shape and welded to the bottom plate to create a box structure. The box structure design increases rigidity and impact resistance.

Boom, Sticks and Attachments

Designed for maximum flexibility to keep productivity and efficiency high on all jobs.

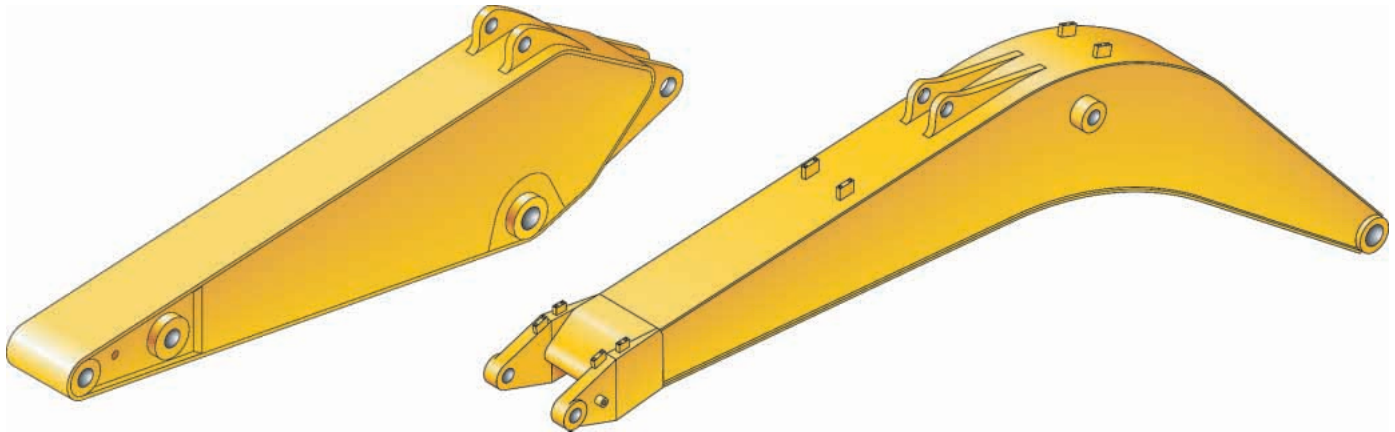

Front Linkage Attachments.

Three length of booms and five types of sticks are available, offering a range of configurations suitable for a wide variety of application conditions.

Boom Construction. The 345D L booms have large cross-sections and internal baffle plates to provide long life and durability. Forged steel is used in critical high-load areas such as the boom-foot and boom cylinder connection.

Long Reach Boom – 7.4 m (23'3") long.

The Long Reach boom, when combined with the 4.3 m (14'1") stick, provides a similar digging envelope to the previous 345C. This boom/stick combination has a significantly reduced transport height, eliminating the need to remove the stick cylinder pin.

HD Reach Boom – 6.9 m (22'8") long.

The Heavy Duty (HD) Reach boom is designed to balance reach, digging force and bucket capacity, making it ideal for a wide range of applications.

Mass Excavation Boom – 6.55 m (21'6") long.

The mass boom is designed to provide maximum digging forces, bucket capacity and truck loading productivity. The mass boom comes with two stick options for further job site versatility.

Stick Construction. The 345D L sticks are made of high-tensile strength steel, using a large box section design, interior baffle plates and an additional bottom guard.

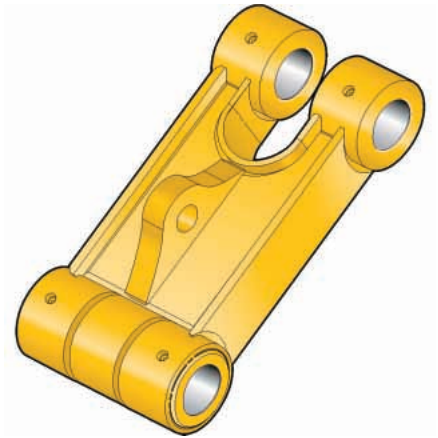

Power Link. The 345D L power link improves durability, increases machine-lifting capability in key lifting positions, and is easier to use compared to the previous lift bar designs.

Work Tools

The 345D L has an extensive selection of work tools to optimize machine performance.



Work Tools. Choose from a variety of work tools such as hammers, shears, pulverizers, compactors, multi-processors, sorting grapples and couplers. Ask your Cat dealer for information on attachments or special configurations.

General Purpose Buckets. General purpose (GP) buckets are best suited for digging in low-impact, moderately abrasive materials such as dirt, loam, gravel and clay.

Heavy Duty Buckets. Heavy duty (HD) buckets are designed for a wide range of moderately abrasive applications such as mixed dirt, clay and rock. HD buckets have optimized loading and dumping characteristics and more robust construction than the GP buckets.

Heavy-Duty Power Buckets. Heavy duty power (HDP) buckets are for use in moderately abrasive applications where

breakout force and cycle times are critical. Decreased tip radius maximizes tip force and improves cycle times in most materials. Not ideal for use in sticky material conditions. Cutting edge and GET are up-sized.

Heavy Duty Rock Buckets. Heavy duty rock (HDR) buckets are designed for aggressive bucket loading in highly abrasive applications such as shot rock and granite. Features include:

- Thick wear plates to extend the life of the bucket in severe applications.
- Side wear plates that extend further up the side of the bucket for maximum protection in rocky soils.
- Sidebar protectors are available for sidebar protection, or side-cutters can be used to provide increased fill characteristics and bucket wear protection.

Rock Ripping Buckets. Rock ripping (RR) buckets are ruggedly constructed, narrow buckets for ripping in applications where material penetration and an inability to blast is an issue. The aggressive lip-type ripping design uses five sharp or twin sharp teeth in a staggered position. The staggered design allows one or two tips to penetrate first, providing higher breakout forces.



Caterpillar Ground Engaging Tools (GET). Caterpillar K Series™ GET is featured on the 345D L buckets. The K Series™ system uses a vertical retainer, which is easier to remove and install than the old Cat J Series pin. There are a variety of teeth, side cutters, and sidebar protectors to match operating conditions.

- The teeth are designed to be extremely aggressive and offer excellent penetration.
- The side-cutter design is aggressive in trenching applications, improving efficiency and bucket payload.

Service Life. Caterpillar® buckets increase service life and reduce repair costs.

- Dual radius design for increased life and reduced wear.
- Robot welding of hinge assembly for increased weld penetration and longer life.
- Incorporates the aggressive and easier to install K Series™ GET system.
- High strength and heat-treated steel that exceeds T-1 in high wear areas.

Versatility

A wide variety of optional and factory-installed attachments are available to enhance performance and improve job site management.



Tool Control System. The optional tool control system maximizes work tool productivity by configuring hydraulic flow, pressure, and operator controls to match a specific work tool. System versatility enables a wide range of tools to be used.

Auxiliary Hydraulic Valve. A hydraulically controlled auxiliary valve is standard on the 345D L. Control circuits are available as attachments, allowing operation of high and medium pressure tools such as shears, grapples, hammers, pulverizers, multi-processors and vibratory plate compactors.

Product Link. Product Link 321 is now standard on the 345D L. The optional levels of service, including Asset Watch, Maintenance Watch, and Health Watch allow you to monitor and maintain your equipment for the lowest operating cost.

Control Levers. Three types of tool controls are available to meet the operator's individual preference.

- **Foot Pedal** – The hydraulic modulated foot pedal is used in conjunction with the hydraulic controller.
- **Foot Switch** – The electric on/off switch pedal is used in conjunction with either the hydraulic controller or attachment controller. The foot switch is located on cab floor.
- **Tool Controller Joystick** – Two types of the tool controller joysticks are available. The joystick with the modulation switch has two on/off switches, one trigger switch and one modulation switch. The joystick without the modulation switch has three on/off switches and one trigger switch.



Machine Security. An optional Machine Security System is available from the factory on the 345D L. This system controls when the machine can be operated and utilizes specific keys to prevent unauthorized machine use, a significant theft deterrent.

AccuGrade™ Grade Control System for Hydraulic Excavators

The AccuGrade Excavator System design integrates the scalable machine control and guidance system to optimize performance, reliability and productivity.

Overview. The AccuGrade System for Hydraulic Excavators reduces guesswork and costly rework by moving material right the first time, reduces survey costs up to 90%, and increases material utilization. The system improves operator skills, which reduces labor requirements, aids operators in maintaining a consistent grade and slope across the worksite, and reduces material cost.



The AccuGrade Attachment Ready Option (ARO) Machine. The ARO supports all kits and integrates the critical sensors with the machine right out of the factory. The design uses advanced Position Sensing Cylinder (PSC) technology as well as heavy duty rotary sensors. With the PSC, the AccuGrade system determines the current cylinder length and the current position of the bucket tip in real time.

The PSC also removes the front linkage sensors from the traditional high wear areas such as the bucket linkage, and places them safely inside the bucket cylinder for increased integration, responsiveness, and reliability.

The ARO uses a Controller Area Network (CAN) designed for plug-and-play capability. Simply mount the components, connect, calibrate and the system is ready to operate. All wiring and necessary welded brackets are factory installed as part of the ARO.



AccuGrade Site Reference Kit.

The AccuGrade Site Reference system provides the operator with precise, real-time bucket positioning relative to the desired grade. Using a combination of sensors, the system calculates bucket tip position relative to a grade/survey stake or benchmark.

AccuGrade Laser Reference Kit.

The optional system allows the machine to move after obtaining a reference benchmark. The laser receiver attachment references a rotating laser to calculate the desired grade for elevation changes over large work sites, significantly increasing productivity.

AccuGrade GPS Kit.

AccuGrade GPS uses 3D design files that are stored on the in-cab display and is able to use satellites in both the US and the GLONASS satellite constellation to augment the GPS solution and define the location of the machine on the job site. With the addition of the machine position to the location of the bucket determined by the machine-mounted components, AccuGrade GPS then compares the position of the bucket relative to the site design plan and delivers real-time information to the operator.

Applications. The Site and Laser Reference systems are ideal for building pads, trenches, and general utility applications. The 3D system is ideal for all applications, including finishing slopes, excavating and truck loading, complex trenches, and sites with 3D designs, such as retention ponds and golf courses.

Service and Maintenance

Simplified service and maintenance save you time and money.

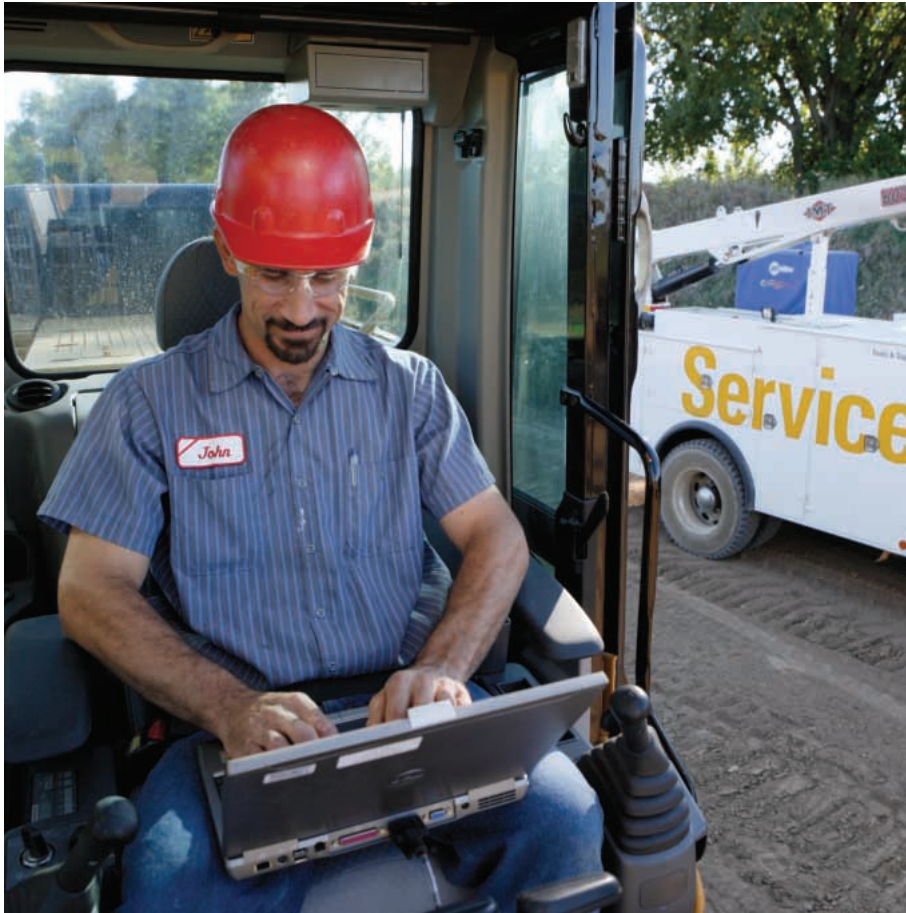

Extended Service Intervals.

Extended service and maintenance intervals increase machine availability. The maintenance intervals for engine oil and engine oil filter have been extended to 500 hours.

Capsule Filter. The hydraulic return filters are located in the hydraulic tank. The filter elements are removable without spilling hydraulic oil.

Pilot Hydraulic System Filter.

The pilot hydraulic system filter keeps contaminants from the pilot system and is located in the pump compartment.

Radial Seal Main Air Cleaner. The radial seal main air cleaner with pre-cleaner has a double-layered filter element for more efficient filtration. No tools are required to change the element.

Fuel-Water Separator. The water separator has a primary fuel filter element and is located in the battery compartment for easy access from the ground.

Service Points. Service points are centrally located with easy access to facilitate routine maintenance.



Oil Sample and Pressure Ports.

Oil sample and pressure ports provide easy checking of machine condition and are standard on every machine.

Greasing Points. A concentrated remote greasing block on the boom delivers grease to hard-to-reach locations.

Complete Customer Support

Cat dealer services help you operate longer with lower costs.



Product Support. You will find nearly all parts at our dealer parts counter. Cat dealers utilize a worldwide computer network to find in-stock parts to minimize machine downtime. You can save money with Cat remanufactured components.

Machine Selection. Make detailed comparisons of the machines you are considering before you buy. What are the job requirements, machine attachments and operating hours? What production is needed? Your Cat dealer can provide recommendations.

Purchase. Look past initial price. Consider the financing options available as well as day-to-day operating costs. This is also the time to look at dealer services that can be included in the cost of the machine to yield lower equipment owning and operating costs over the long run.

Customer Support Agreements. Cat dealers offer a variety of product support agreements, and work with customers to develop a plan that best meets specific needs. These plans can cover the entire machine, including attachments, to help protect your investment.

Operation. Improving operating techniques can boost your profits. Your Cat dealer has videotapes, literature and other ideas to help you increase productivity, and Caterpillar offers certified operator training classes to help maximize the return on your investment.

Maintenance Services. Repair option programs guarantee the cost of repairs up front. Diagnostic programs such as Scheduled Oil Sampling, Coolant Sampling and Technical Analysis help you avoid unscheduled repairs.

Replacement. Repair, rebuild or replace? Your Cat Dealer can help you evaluate the cost involved so you can make the right choice.

SAFETY.CAT.COM™.

Engine

Engine Model	Cat C13 ACERT	
Net Flywheel Power	283 kW	380 hp
Net Power – ISO 9249	283 kW	380 hp
Net Power – SAE J1349	283 kW	380 hp
Net Power – EEC 80/1269	283 kW	380 hp
Bore	130 mm	5.1 in
Stroke	157 mm	6.2 in
Displacement	12.5 L	763 in ³
Cylinders	6	

- The 345D L meets U.S. EPA Tier 3 and EU Stage IIIA exhaust emission requirements.
- Net power advertised is the power available at the flywheel when the engine is equipped with fan, air cleaner, muffler and alternator.
- No engine derating needed up to 2300 m (7,500 ft).

Weights

Operating Weight – Long Undercarriage	45 375 kg	100,040 lb
Operating Weight – Long Variable	49 265 kg	108,610 lb

- 6.9 m (22'8") HD Reach Boom, R3.9m (12'10") Stick, 1219 mm (48") GP-C Bucket, 750 mm (30") TG Track Shoes, Long Undercarriage

Swing Mechanism

Swing Speed	8.7 rpm	
Swing Torque	148.5 kN-m	109,560 lb ft

Drive

Maximum Travel Speed	4.5 km/h	2.8 mph
Maximum Drawbar Pull – Long Undercarriage	337.7 kN	75,920 lb

Service Refill Capacities

Fuel Tank Capacity	705 L	186 gal
Cooling System	35.5 L	9.4 gal
Engine Oil	42 L	11 gal
Swing Drive (each)	10 L	2.6 gal
Final Drive (each)	15 L	4 gal
Hydraulic System (including tank)	570 L	150 gal
Hydraulic Tank	243 L	64 gal

Hydraulic System

Main System – Maximum Flow (Total)	734 L/min	194 gal/min
Maximum Pressure – Equipment – Normal	35 000 kPa	5,080 psi
Maximum Pressure – Equipment – Heavy Lift	38 000 kPa	5,511 psi
Maximum Pressure – Travel	35 000 kPa	5,080 psi
Maximum Pressure – Swing	31 400 kPa	4,550 psi
Pilot System – Maximum flow	43 L/min	11 gal/min
Pilot System – Maximum pressure	4110 kPa	596 psi
Boom Cylinder – Bore	160 mm	6.3 in
Boom Cylinder – Stroke	1575 mm	62 in
Stick Cylinder – Bore	190 mm	7.5 in
Stick Cylinder – Stroke (for Long Reach and Reach fronts)	1778 mm	70 in
Stick Cylinder – Stroke (for mass excavation fronts)	1758 mm	69.2 in
TB Family Bucket Cylinder – Bore	160 mm	6.3 in
TB Family Bucket Cylinder – Stroke	1356 mm	53.4 in
UB Family Bucket Cylinder – Bore	170 mm	6.7 in
UB Family Bucket Cylinder – Stroke	1396 mm	55 in
Main normal relief pressure	35 000 kPa	5,080 psi

Sound Performance

Performance	ANSI/SAE J1166 MAY90 Meets OSHA and MSHA Requirements
-------------	--

- When properly installed and maintained, the cab offered by Caterpillar, when tested with doors and windows closed according to ANSI/SAE J1166 OCT 98, meets OSHA and MSHA requirements for operator sound exposure limits in effects at time of manufacture.
- Hearing protection may be needed when operating with an open operator station and cab (when not properly maintained or doors/windows open) for extended periods or in noisy environment.

Standards

Brakes	SAE J1026 APR90
Cab/FOGS	SAE J1356 FEB 88 and ISO 10262-1998

Dimensions

All dimensions are approximate.

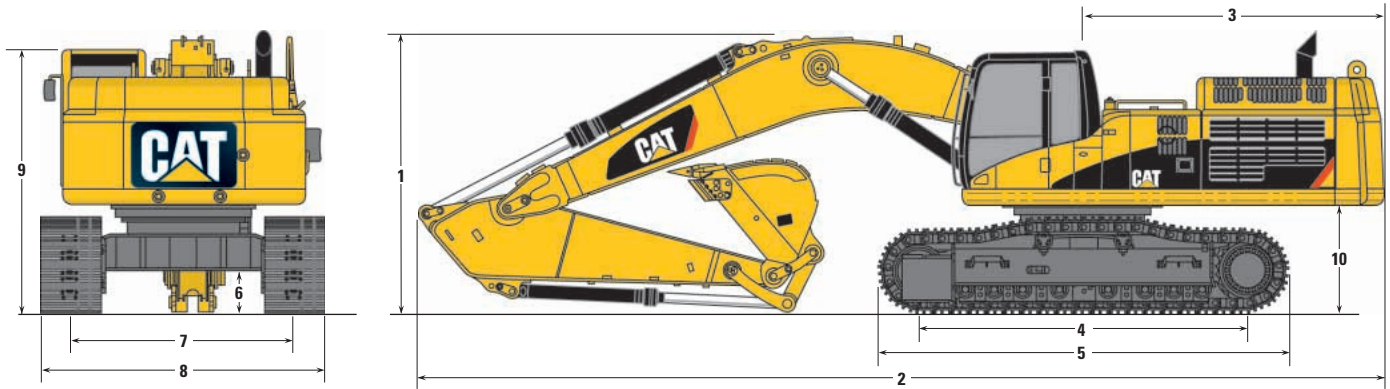

Boom	Long Reach Boom 7.4 m (24'3")		HD Reach Boom 6.9 m (22'8")		Mass Boom 6.55 m (21'6")	
Stick	R4.3TB (14'1")	R3.9TB (12'10")	R3.9TB (12'10")	R3.35TB (11'0")	M3.0UB (9'10")	M2.5UB (8'2")
1 Shipping Height						
Fixed Gauge Undercarriage	3680 mm (12'1")	3570 mm (11'8")	3660 mm (12'0")	3690 mm (12'1")	4020 mm (13'2")	3960 mm (13'0")
Variable Gauge Undercarriage	3630 mm (11'11")	3550 mm (11'7")	3640 mm (11'11")	3720 mm (12'2")	4050 mm (13'3")	4000 mm (13'2")
2 Shipping Length						
Fixed Gauge Undercarriage	12 450 mm (40'10")	12 430 mm (40'9")	11 950 mm (39'2")	11 940 mm (39'2")	11 640 mm (38'2")	11 710 mm (38'5")
Variable Gauge Undercarriage	12 400 mm (40'8")	12 370 mm (40'7")	11 910 mm (39'1")	11 910 mm (39'1")	11 620 mm (38'1")	11 680 mm (38'4")
3 Tail Swing Radius	3770 mm (12'4")	3770 mm (12'4")	3770 mm (12'4")	3770 mm (12'4")	3770 mm (12'4")	3770 mm (12'4")
Undercarriage			Fixed Gauge	Variable Gauge	Wide Variable Gauge	
4 Length to Center of Rollers			4360 mm (14'4")	4340 mm (14'3")	4340 mm (14'3")	
5 Track Length			5360 mm (17'7")	5340 mm (17'6")	5340 mm (17'6")	
6 Ground Clearance			510 mm (1'8")	740 mm (2'5")	740 mm (2'5")	
7 Track Gauge						
Retracted (Transport) Position			2740 mm (9'0")	2640 mm (8'8")	2760 mm (9'1")	
Extended (Working) Position			2740 mm (9'0")	2890 mm (9'6")	3240 mm (10'8")	
8 Track Width*						
Retracted (Transport) Position			3640 mm (11'11")	3540 mm (11'7")	3660 mm (12'0")	
Extended (Working) Position			3640 mm (11'11")	3790 mm (12'5")	4140 mm (13'7")	
9 Cab Height			3210 mm (10'6")	3360 mm (11'0")	3360 mm (11'0")	
10 Counterweight Height (to bottom)			1320 mm (4'4")	1470 mm (4'10")	1470 mm (4'10")	

* Track width shown is for 900 mm (36") track shoes. Subtract 150 mm (6") for 750 mm (30") track shoes.

HD Reach Working Ranges

Heavy Duty (HD) Reach boom configuration

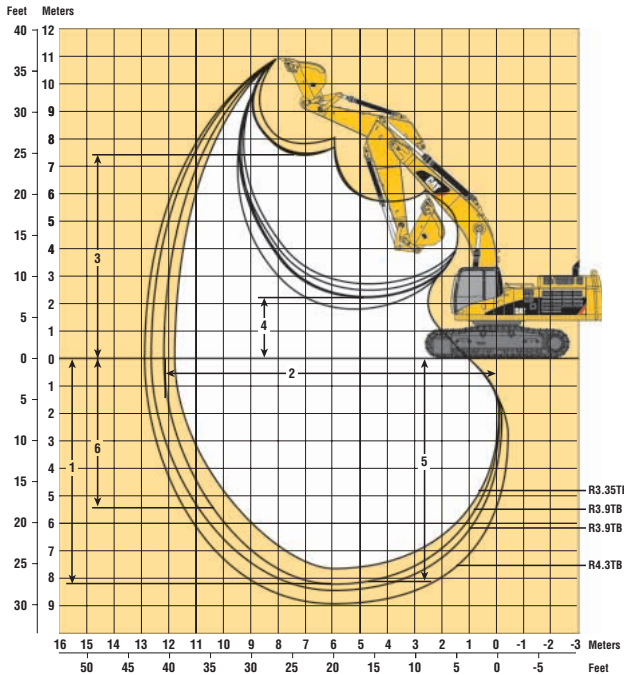

Mass Working Ranges

Mass (M) boom configuration

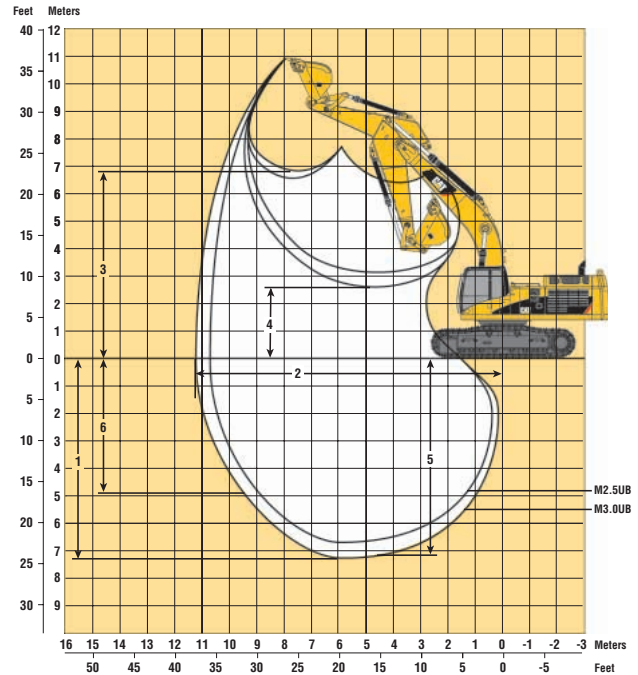

345D L Working Ranges – Long Fixed Gauge Undercarriage

Stick	Long Reach Boom		HD Reach Boom		Mass Excavation Boom	
	R4.3TB (14'1")	R3.9TB (12'10")	R3.9TB (12'10")	R3.35TB (11'0")	M3.0UB (9'10")	M2.5UB (8'2")
Bucket	GP-C 1.8 m ³ GP-C 2.36 yd ³	GP-C 1.8 m ³ GP-C 2.36 yd ³	GP-C 1.8 m ³ GP-C 2.36 yd ³	GP-C 1.8 m ³ GP-C 2.36 yd ³	HD 3.11 m ³ HD 4.07 yd ³	HD 3.11 m ³ HD 4.07 yd ³
1 Maximum Digging Depth	8920 mm (29'3")	8520 mm (27'11")	8200 mm (26'11")	7650 mm (25'1")	7200 mm (23'7")	6700 mm (22'0")
2 Maximum Reach at Ground Level	12 940 mm (42'5")	12 580 mm (41'3")	12 120 mm (39'9")	11 710 mm (38'5")	11 160 mm (36'7")	10 700 mm (35'1")
3 Maximum Loading Height	7870 mm (25'10")	7750 mm (25'5")	7410 mm (24'4")	7420 mm (24'4")	6830 mm (22'5")	6640 mm (21'9")
4 Minimum Loading Height	2240 mm (7'4")	2640 mm (8'8")	2200 mm (7'3")	2750 mm (9'0")	2670 mm (8'10")	3170 mm (10'5")
5 Maximum Depth Cut for 2440 mm (8') Level Bottom	8790 mm (28'10")	8380 mm (27'6")	8070 mm (26'6")	7500 mm (24'7")	7050 mm (23'1")	6530 mm (21'5")
6 Maximum Vertical Wall Digging Depth	5860 mm (19'3")	5330 mm (17'6")	5300 mm (17'4")	5210 mm (17'1")	4660 mm (15'3")	4220 mm (13'10")

345D L Working Ranges with Pin Grabber Coupler – Long Fixed Gauge Undercarriage

Stick	HD Reach Boom R3.35TB (11'0")
Bucket with UB-Family Coupler	GP-C 1.8 m ³ GP-C 2.36 yd ³
1 Maximum Digging Depth	8010 mm (26'4")
2 Maximum Reach at Ground Level	12 070 mm (39'7")
3 Maximum Loading Height	7060 mm (23'1")
4 Minimum Loading Height	2400 mm (7'11")
5 Maximum Depth Cut for 2440 mm (8') Level Bottom	7870 mm (25'10")
6 Maximum Vertical Wall Digging Depth	4010 mm (13'2")

HD Reach Working Ranges

Heavy Duty (HD) Reach boom configuration

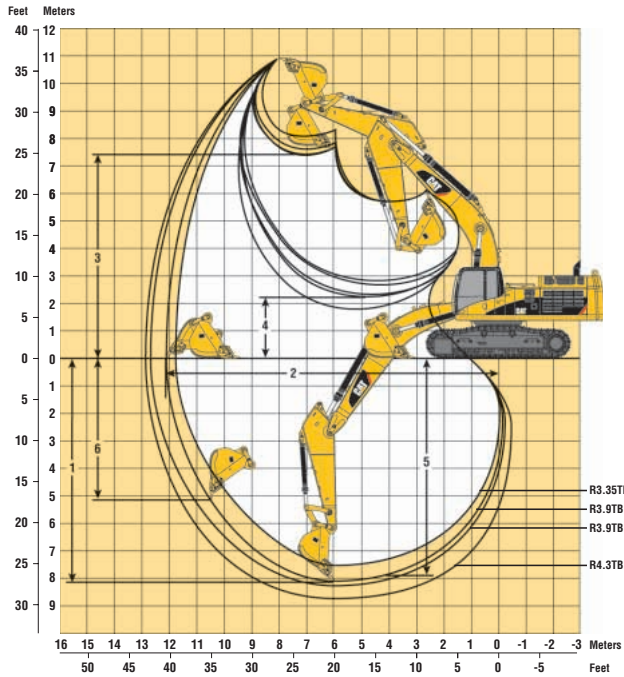

Mass Working Ranges

Mass (M) boom configuration

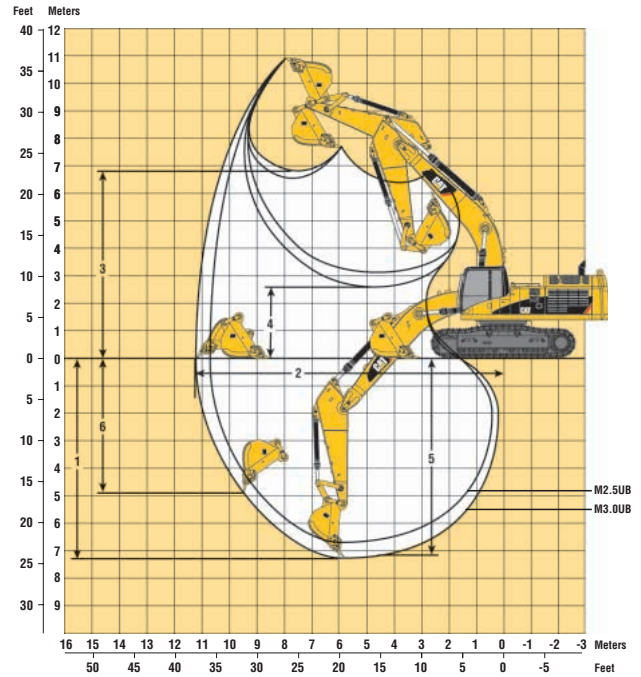

345D L Working Ranges – Long Variable Gauge Undercarriage

Stick	Long Reach Boom		HD Reach Boom		Mass Excavation Boom	
	R4.3TB (14'1")	R3.9TB (12'10")	R3.9TB (12'10")	R3.35TB (11'0")	M3.0UB (9'10")	M2.5UB (8'2")
Bucket	GP-C 1.8 m ³ GP-C 2.36 yd ³	GP-C 1.8 m ³ GP-C 2.36 yd ³	GP-C 1.8 m ³ GP-C 2.36 yd ³	GP-C 1.8 m ³ GP-C 2.36 yd ³	HD 3.11 m ³ HD 4.07 yd ³	HD 3.11 m ³ HD 4.07 yd ³
1 Maximum Digging Depth	8770 mm (28'9")	8370 mm (27'6")	8050 mm (26'5")	7500 mm (24'7")	7200 mm (23'8")	6700 mm (22'0")
2 Maximum Reach at Ground Level	12 910 mm (42'4")	12 550 mm (41'2")	12 100 mm (39'8")	11 680 mm (38'4")	11 160 mm (36'7")	10 700 mm (35'2")
3 Maximum Loading Height	8010 mm (26'4")	7890 mm (25'11")	7550 mm (24'9")	7570 mm (24'10")	6830 mm (22'5")	6640 mm (21'9")
4 Minimum Loading Height	2380 mm (7'10")	2780 mm (9'1")	2350 mm (7'9")	2900 mm (9'6")	2670 mm (8'9")	3170 mm (10'5")
5 Maximum Depth Cut for 2440 mm (8') Level Bottom	8650 mm (28'4")	8230 mm (27'0")	7920 mm (26'0")	7360 mm (24'2")	7050 mm (23'1")	6530 mm (21'5")
6 Maximum Vertical Wall Digging Depth	5720 mm (18'9")	5190 mm (17'0")	5160 mm (16'11")	5070 mm (16'7")	4660 mm (15'3")	4220 mm (13'10")

345D L Working Ranges with Pin Grabber Coupler – Long Variable Gauge Undercarriage

Stick	HD Reach Boom R3.35TB (11'0")
Bucket with UB-Family Coupler	GP-C 1.8 m ³ GP-C 2.36 yd ³
1 Maximum Digging Depth	7860 mm (25'9")
2 Maximum Reach at Ground Level	12 040 mm (39'5")
3 Maximum Loading Height	7210 mm (23'8")
4 Minimum Loading Height	2540 mm (8'4")
5 Maximum Depth Cut for 2440 mm (8') Level Bottom	7730 mm (25'4")
6 Maximum Vertical Wall Digging Depth	3860 mm (12'8")

Operating Weight*

	kg	lb		kg	lb
Complete Machine Equipped with:			Differences for Other Buckets:		
6.9 m (22'8") HD Reach Boom, R3.9m (12'10") Stick, 1219 mm (48") GP-C Bucket, Long Fixed Gauge Undercarriage with 750 mm (30") TG Track Shoes, 7610 kg (16,780 lb) Counterweight without Removal Device			See Bucket Specification Chart		
			Differences for Other Undercarriages:		
			Long Variable Gauge Undercarriage		
			Long Wide Variable Gauge Undercarriage		
			Differences for Other Track Shoes:		
			600 mm (24") Double Grouser (DG)		
			900 mm (36") Triple Grouser (TG)		
			Differences for Other Counterweights:		
			7.6 MT Counterweight with Removal Device		
			8.7 MT Counterweight with Removal Device		
			9.0 MT Counterweight without Removal Device		
Differences for Other Booms:					
7.4 m (24'3") Long Reach Boom					
6.55 m (21'6") Mass Excavation Boom					
Differences for Other Sticks:					
R4.3m (14'1") Stick with TB Bucket Linkage and Bucket Cylinder					
R3.35m (11'0") Stick with TB Bucket Linkage and Bucket Cylinder					
M3.0m (9'10") Stick with UB Bucket Linkage and Bucket Cylinder					
M2.5m (8'2") Stick with UB Bucket Linkage and Bucket Cylinder					

* All weights are approximate. Operating weight includes 15% full fuel tank.
Add 520 kg (1,140 lb) for full fuel tank and 75 kg (165 lb) for an average operator.

Work Tool Matching Guide

Boom Options	HD Reach Boom R6.9		
Stick Options	R3.9TB	R3.35TB	Boom Mounted
Tools:			
Contractor's Grapple	G145B	G145B	—
Dedicated Quick Coupler	Yes	Yes	—
Hydraulic Hammer	H160D S/H180D S	H160D S/H180D S	—
Hydraulic Shear	S340	S340	S365B
Hydraulic Thumb	Yes	Yes	—
Multi-Processor	MP30	MP30	—
Pin-Grabber Quick Coupler	Yes	Yes	—
Pulverizer – Mechanical Operation	P130	P130	—
Ripper Tooth	Yes	Yes	—
Shear – Mechanical Operation	S128	S128	—
Sorting and Demolition Grapple	G330	G330	—
Trash Grapple	TG-TB	TG-TB	—

345D L Bucket and Stick Forces

Stick Forces						
TB-Family Buckets	Sticks					
	R4.3		R3.9		R3.35	
	kN	lb	kN	lb	kN	lb
GP-C, HD, HDR						
Stick Digging Force (ISO)	171	38,400	183	41,100	199	44,700
Stick Digging Force (SAE)	167	37,500	179	40,200	194	40,200
HD-P						
Stick Digging Force (ISO)	176	39,500	189	42,400	206	42,400
Stick Digging Force (SAE)	170	38,200	183	41,100	199	41,100
GP-C, HD, HDR with coupler						
Stick Digging Force (ISO)	161	36,100	171	38,400	186	38,400
Stick Digging Force (SAE)	157	35,200	169	37,900	181	37,900
HD-P with coupler						
Stick Digging Force (ISO)	165	37,000	176	39,500	191	39,500
Stick Digging Force (SAE)	161	36,100	172	38,600	187	38,600

UB-Family Buckets	Sticks			
	M3.0		M2.5	
	kN	lb	kN	lb
GP				
Stick Digging Force (ISO)	206	46,200	233	52,300
Stick Digging Force (SAE)	198	44,400	223	50,100
HD, HDR with coupler				
Stick Digging Force (ISO)	213	47,800	242	54,300
Stick Digging Force (SAE)	205	46,000	231	51,900

	Bucket Forces			
	TB-Family Buckets		UB-Family Buckets	
	kN	lb	kN	lb
GP-C, HD, HDR				
Bucket Digging Force (ISO)	268	60,200	240	53,900
Bucket Digging Force (SAE)	238	53,500	212	47,600
HD-P				
Bucket Digging Force (ISO)	300	67,300	263	59,000
Bucket Digging Force (SAE)	258	58,000	230	51,600
GP-C, HD, HDR with coupler				
Bucket Digging Force (ISO)	219	49,200		
Bucket Digging Force (SAE)	200	44,900		
HD-P with coupler				
Bucket Digging Force (ISO)	239	53,700		
Bucket Digging Force (SAE)	217	48,700		

345D L Bucket Specifications and Compatibility

Fixed Gauge Undercarriage

	Capacity*		Width		Tip Radius		Weight w/o tips		Teeth Qty	HD Reach Boom Stick		Long Reach Boom Stick	
	m ³	yd ³	mm	in	mm	in	kg	lb		R3.9TB (12'10")	R3.35TB (11'0")	R4.3TB (14'1")	R3.9TB (12'10")
TB Buckets													
General Purpose – Capacity (GP-C)	1.0	1.32	762	30	1871	73.7	1265	2,790	3	●	●	●	●
	1.2	1.60	914	36	1871	73.7	1490	3,280	4	●	●	●	●
	1.5	1.98	1067	42	1871	73.7	1583	3,490	4	●	●	●	●
	1.8	2.35	1219	48	1871	73.7	1728	3,810	5	●	●	●	●
	2.1	2.75	1372	54	1871	73.7	1850	4,070	5	●	●	○	●
	2.4	3.13	1524	60	1871	73.7	1930	4,250	6	○	●	○	○
	2.8	3.64	1727	68	1871	73.7	2182	4,810	7	○	○	●	●
	3.1	4.03	1880	74	1871	73.7	2308	5,080	7	●	○	●	●
Heavy Duty (HD)	1.1	1.39	914	36	1871	73.7	1549	3,410	4	●	●	●	●
	1.3	1.70	1067	42	1871	73.7	1664	3,670	4	●	●	●	●
	1.6	2.04	1219	48	1871	73.7	1806	3,980	5	●	●	●	●
	1.8	2.37	1372	54	1871	73.7	1931	4,250	5	●	●	●	●
	2.1	2.71	1524	60	1871	73.7	2080	4,580	6	●	●	○	○
	2.4	3.14	1727	68	1871	73.7	2291	5,050	7	○	○	●	○
	2.7	3.51	1880	74	1871	73.7	2397	5,280	7	○	○	●	●
Heavy Duty Rock (HDR)	0.9	1.14	762	30	1871	73.7	1410	3,110	3	●	●	●	●
	1.1	1.39	914	36	1871	73.7	1644	3,620	4	●	●	●	●
	1.3	1.71	1067	42	1871	73.7	1769	3,900	4	●	●	●	●
	1.6	2.04	1219	48	1871	73.7	1923	4,240	5	●	●	●	●
	1.8	2.37	1372	54	1871	73.7	2061	4,540	5	●	●	○	●
	2.1	2.71	1524	60	1871	73.7	2221	4,890	6	●	●	○	○
	2.4	3.14	1676	66	1871	73.7	2451	5,400	7	○	○	●	○
	2.7	3.51	1880	74	1871	73.7	2567	5,650	7	○	○	●	●
Heavy Duty-Power (HD-P)	1.73	2.26	1372	54	1725	67.9	1894	4,170	4	●	●	●	●

	Capacity*		Width		Tip Radius		Weight w/o tips		Teeth Qty	Mass Boom Stick	
	m ³	yd ³	mm	in	mm	in	kg	lb		M3.0UB (9'10")	M2.5UB (8'2")
UB Buckets											
General Purpose (GP)	3.5	4.54	1981	78	2047	80.6	2762	6,080	6	●	○
Heavy Duty (HD)	3.1	4.07	1981	78	1880	74.0	2675	5,890	6	○	●
Heavy Duty Rock (HDR)	2.4	3.17	1524	60	2093	82.4	2544	5,600	4	●	●
	3.1	4.07	1930.4	76	2147	84.5	3013	6,640	6	○	○

Assumptions for maximum material density rating

1. Front linkage fully extended at ground line
2. Bucket curled
3. 100% bucket fill factor

* Capacities based on SAE J296. Some calculations of capacity fall on borderlines. Rounding may allow two buckets to have the same English rating but different metric ratings.

- 2100 kg/m³ (3,500 lb/yd³) max material density
- 1800 kg/m³ (3,000 lb/yd³) max material density
- 1500 kg/m³ (2,500 lb/yd³) max material density
- 1200 kg/m³ (2,000 lb/yd³) max material density
- 900 kg/m³ (1,500 lb/yd³) max material density

345D L Bucket Specifications and Compatibility

Variable Gauge Undercarriage

	Capacity*		Width		Tip Radius		Weight w/o tips		Teeth Qty	HD Reach Boom Stick		Long Reach Boom Stick	
	m ³	yd ³	mm	in	mm	in	kg	lb		R3.9TB (12'10")	R3.35TB (11'0")	R4.3TB (14'1")	R3.9TB (12'10")
TB Buckets													
General Purpose – Capacity (GP-C)	1.0	1.32	762	30	1871	73.6	1265	2,790	3	●	●	●	●
	1.2	1.60	914	36	1871	73.6	1490	3,280	4	●	●	●	●
	1.5	1.98	1067	42	1871	73.6	1583	3,490	4	●	●	●	●
	1.8	2.35	1219	48	1871	73.6	1728	3,810	5	●	●	●	●
	2.1	2.75	1372	54	1871	73.6	1850	4,070	5	●	●	●	●
	2.4	3.13	1524	60	1871	73.6	1930	4,250	6	●	●	○	●
	2.8	3.64	1676	66	1871	73.6	2182	4,810	7	○	●	○	○
	3.1	4.03	1880	74	1871	73.6	2308	5,080	7	○	○	●	○
Heavy Duty (HD)	1.1	1.39	914	36	1871	73.6	1549	3,410	4	●	●	●	●
	1.3	1.70	1067	42	1871	73.6	1664	3,670	4	●	●	●	●
	1.6	2.04	1219	48	1871	73.6	1806	3,980	5	●	●	●	●
	1.8	2.37	1372	54	1871	73.6	1931	4,250	5	●	●	●	●
	2.1	2.71	1524	60	1871	73.6	2080	4,580	6	●	●	●	●
	2.4	3.14	1676	66	1871	73.6	2291	5,050	7	●	●	○	○
	2.7	3.51	1880	74	1871	73.6	2397	5,280	7	○	●	○	○
Heavy Duty Rock (HDR)	0.9	1.14	762	30	1871	73.6	1410	3,110	3	●	●	●	●
	1.1	1.39	914	36	1871	73.6	1644	3,620	4	●	●	●	●
	1.3	1.71	1067	42	1871	73.6	1769	3,900	4	●	●	●	●
	1.6	2.04	1219	48	1871	73.6	1923	4,240	5	●	●	●	●
	1.8	2.37	1372	54	1871	73.6	2061	4,540	5	●	●	●	●
	2.1	2.71	1524	60	1871	73.6	2221	4,890	6	●	●	○	●
	2.4	3.14	1676	66	1871	73.6	2451	5,400	7	●	●	○	○
	2.7	3.51	1880	74	1871	73.6	2567	5,650	7	○	○	●	○
Heavy Duty-Power (HD-P)	1.73	2.26	1372	54	1725	67.9	1894	4,170	4	●	●	●	●
UB Buckets													
General Purpose (GP)	3.5	4.54	1981.2	78	2047	80.6	2762	6,080	6	○	○		
Heavy Duty (HD)	3.1	4.07	1981.2	78	1880	74.0	2675	5,890	6	○	●		
Heavy Duty Rock (HDR)	2.4	3.17	1524	60	2093	82.4	2544	5,600	4	●	●		
	3.1	4.07	1930.4	76	2147	84.5	3013	6,640	6	○	○		

Assumptions for maximum material density rating

1. Front linkage fully extended at ground line
2. Bucket curled
3. 100% bucket fill factor

* Capacities based on SAE J296. Some calculations of capacity fall on borderlines. Rounding may allow two buckets to have the same English rating but different metric ratings.

- 2100 kg/m³ (3,500 lb/yd³) max material density
- 1800 kg/m³ (3,000 lb/yd³) max material density
- 1500 kg/m³ (2,500 lb/yd³) max material density
- 1200 kg/m³ (2,000 lb/yd³) max material density
- 900 kg/m³ (1,500 lb/yd³) max material density

345D L Bucket Specifications and Compatibility

Wide Variable Gauge Undercarriage

	Capacity*		Width		Tip Radius		Weight w/o tips		Teeth Qty	HD Reach Boom Stick		Long Reach Boom Stick	
										R3.9TB (12'10")	R3.35TB (11'0")	R4.3TB (14'1")	R3.9TB (12'10")
	m ³	yd ³	mm	in	mm	in	kg	lb					
TB Buckets													
General Purpose – Capacity (GP-C)	1.0	1.32	762	30	1871	73.6	1265	2,790	3	●	●	●	●
	1.2	1.60	914	36	1871	73.6	1490	3,280	4	●	●	●	●
	1.5	1.98	1067	42	1871	73.6	1583	3,490	4	●	●	●	●
	1.8	2.35	1219	48	1871	73.6	1728	3,810	5	●	●	●	●
	2.1	2.75	1372	54	1871	73.6	1850	4,070	5	●	●	●	●
	2.4	3.13	1524	60	1871	73.6	1930	4,250	6	●	●	●	●
	2.8	3.64	1676	66	1871	73.6	2182	4,810	7	●	●	○	●
	3.1	4.03	1880	74	1871	73.6	2308	5,080	7	●	●	○	○
Heavy Duty (HD)	1.1	1.39	914	36	1871	73.6	1549	3,410	4	●	●	●	●
	1.3	1.70	1067	42	1871	73.6	1664	3,670	4	●	●	●	●
	1.6	2.04	1219	48	1871	73.6	1806	3,980	5	●	●	●	●
	1.8	2.37	1372	54	1871	73.6	1931	4,250	5	●	●	●	●
	2.1	2.71	1524	60	1871	73.6	2080	4,580	6	●	●	●	●
	2.4	3.14	1676	66	1871	73.6	2291	5,050	7	●	●	●	●
	2.7	3.51	1880	74	1871	73.6	2397	5,280	7	●	●	○	●
Heavy Duty Rock (HDR)	0.9	1.14	762	30	1871	73.6	1410	3,110	3	●	●	●	●
	1.1	1.39	914	36	1871	73.6	1644	3,620	4	●	●	●	●
	1.3	1.71	1067	42	1871	73.6	1769	3,900	4	●	●	●	●
	1.6	2.04	1219	48	1871	73.6	1923	4,240	5	●	●	●	●
	1.8	2.37	1372	54	1871	73.6	2061	4,540	5	●	●	●	●
	2.1	2.71	1524	60	1871	73.6	2221	4,890	6	●	●	●	●
	2.4	3.14	1676	66	1871	73.6	2451	5,400	7	●	●	●	●
	2.7	3.51	1880	74	1871	73.6	2567	5,650	7	●	●	○	●
Heavy Duty-Power (HD-P)	1.73	2.26	1372	54	1725	67.9	1894	4,170	4	●	●	●	●

	Capacity*		Width		Tip Radius		Weight w/o tips		Teeth Qty	Mass Boom Stick	
										M3.0UB (9'10")	M2.5UB (8'2")
	m ³	yd ³	mm	in	mm	in	kg	lb			
UB Buckets											
General Purpose (GP)	3.5	4.54	1981.2	78	2047	80.6	2762	6,080	6	○	●
Heavy Duty (HD)	3.1	4.07	1981.2	78	1880	74.0	2675	5,890	6	●	●
Heavy Duty Rock (HDR)	2.4	3.17	1524	60	2093	82.4	2544	5,600	4	●	●
	3.1	4.07	1930.4	76	2147	84.5	3013	6,640	6	○	●

Assumptions for maximum material density rating

1. Front linkage fully extended at ground line
2. Bucket curled
3. 100% bucket fill factor

* Capacities based on SAE J296. Some calculations of capacity fall on borderlines. Rounding may allow two buckets to have the same English rating but different metric ratings.

- 2100 kg/m³ (3,500 lb/yd³) max material density
- 1800 kg/m³ (3,000 lb/yd³) max material density
- 1500 kg/m³ (2,500 lb/yd³) max material density
- 1200 kg/m³ (2,000 lb/yd³) max material density
- 900 kg/m³ (1,500 lb/yd³) max material density

HD Reach Boom Lift Capacities



Load Point Height



Load Radius Over Front



Load Radius Over Side



Load at Maximum Reach – Bucket Curled



Load at Maximum Reach

BOOM – 6.9 m (22'8")
STICK – 3.9 m (12'10")

BUCKET – GP-C 2.36 yd³ – 1820 kg (4,013 lb)
SHOES – 900 mm (36") triple grouser

UNDERCARRIAGE – Long – fixed gauge
COUNTERWEIGHT – 9000 kg (19,842 lb)

	4.5 m/15.0 ft		6.0 m/20.0 ft		7.5 m/25.0 ft		9.0 m/30.0 ft		10.5 m/35.0 ft									
													m ft			m ft		
9.0 m 30.0 ft	kg lb												*6460 *14,360	*6460 *14,360	6.83 21.99	*4410 *9,800	*4410 *9,800	9.99 32.42
7.5 m 25.0 ft	kg lb						*7540 *14,950	7260 *14,950					*6110 *13,500	*6110 *13,500	7.92 25.75	*4280 *9,450	*4280 *9,450	10.92 35.63
6.0 m 20.0 ft	kg lb						*8370 *18,300	7180 15,350					*6050 *13,330	5730 12,750	8.65 28.27	*4290 *9,450	*4290 *9,450	11.53 37.73
4.5 m 15.0 ft	kg lb					*10 000 *21,700	9690 20,850	*8940 *19,450	6970 14,950	*6640 5090			*6190 *13,630	5080 11,260	9.11 29.85	*4420 *9,750	4000 8,850	11.88 38.93
3.0 m 10.0 ft	kg lb	*19 080 *41,000	*19 080 *41,000	*13 930 *30,050	13 170 28,400	*11 260 *24,400	9170 19,700	*9650 *20,950	6680 14,350	*8510 *16,400	4960 10,600	*6550 *14,400	4730 10,440	9.33 30.61	*4670 *10,250	3800 8,400	11.99 39.34	
1.5 m 5.0 ft	kg lb	*22 710 *48,950	18 880 40,700	*15 960 *34,500	12 220 26,350	*12 450 *26,950	8640 18,600	*10 350 *22,450	6380 13,700	8390 18,000	4810 10,300	*7140 *15,720	4600 10,140	9.33 30.63	*5050 *11,100	3770 8,300	11.88 38.99	
Ground Line	kg lb	*24 410 *52,800	17 810 38,300	*17 290 *37,400	11 530 24,850	*13 320 *28,850	8220 17,700	10 630 22,850	6130 13,150	8250 *16,650	4680 10,000	8070 *17,800	4680 10,320	9.11 29.9	*5620 *12,400	3920 8,650	11.54 37.86	
-1.5 m -5.0 ft	kg lb	*24 450 *53,000	17 400 37,400	*17 740 *38,400	11 150 24,000	*13 670 *29,600	7950 17,100	10 450 22,450	5970 12,800			8970 *19,810	5020 11,080	8.66 28.37	*6470 *14,300	4290 9,500	10.95 35.88	
-3.0 m -10.0 ft	kg lb	*23 220 *50,250	17 390 37,350	*17 230 *37,250	11 040 23,750	*13 320 *28,750	7850 16,900	10 410 22,400	5930 12,750			*9600 *21,170	5730 12,710	7.93 25.92	*7830 *17,400	5020 11,150	10.05 32.87	
-4.5 m -15.0 ft	kg lb	*20 670 *44,600	17 670 38,000	*15 610 *33,600	11 160 24,000	*11 960 *25,550	7940 17,100					*9590 *21,120	7150 15,990	6.86 22.32				
-6.0 m -20.0 ft	kg lb	*16 280 *34,600	*16 280 *34,600	*12 250 *25,800	11 550 24,950							*8900 *19,410	*8900 *19,410	5.3 16.96				

* Limited to hydraulic capacity rather than tipping load. The above loads are in compliance with hydraulic excavator lift capacity rating standard ISO 10567. They do not exceed 87% of hydraulic lifting capacity or 75% of tipping capacity. All lifts with heavy lift on.



Load Point Height



Load Radius Over Front



Load Radius Over Side



Load at Maximum Reach

BOOM – 6.9 m (22'8")
STICK – 3.9 m (12'10")

BUCKET – Bare coupler – 934 kg (2,059 lb)
SHOES – 900 mm (36") triple grouser

UNDERCARRIAGE – Long – fixed gauge
COUNTERWEIGHT – 9000 kg (19,842 lb)

	3.0 m/10.0 ft		4.5 m/15.0 ft		6.0 m/20.0 ft		7.5 m/25.0 ft		9.0 m/30.0 ft		10.5 m/35.0 ft					
															m ft	
9.0 m 30.0 ft	kg lb													*15,830 *15,830	25.47	
7.5 m 25.0 ft	kg lb								*8070 *16,150	7800 *16,150				*6800 *15,030	*6800 *15,030	8.93 29.06
6.0 m 20.0 ft	kg lb								*8990 *19,700	7700 16,500				*6730 *14,840	6480 14,410	9.66 31.56
4.5 m 15.0 ft	kg lb						*10 570 *22,950	10 150 21,850	*9550 *20,800	7470 16,050				*6860 *15,100	5820 12,880	10.13 33.19
3.0 m 10.0 ft	kg lb			*19 630 *42,200	*19 630 *42,200	*14 480 *31,300	13 600 29,300	*11 840 *25,650	9630 20,750	*10 260 *22,300	7180 15,450	*8930 *17,400	5500 11,750	*7170 *15,770	5430 12,000	10.39 34.08
1.5 m 5.0 ft	kg lb			*23 360 *50,400	19 400 41,800	*16 560 *35,800	12 700 27,400	*13 050 *28,300	9120 19,650	*10 950 *23,800	6880 14,800	8900 19,150	5340 11,450	*7690 *16,930	5270 11,610	10.44 34.26
Ground Line	kg lb	*9780 *22,200	*9780 *22,200	*25 120 *54,350	18 400 39,600	*17 930 *38,800	12 040 25,950	*13 930 *30,200	8720 18,750	11 120 23,900	6640 14,300	8760 *17,450	5210 11,200	*8510 *18,750	5290 11,670	10.29 33.76
-1.5 m -5.0 ft	kg lb	*14 540 *32,800	*14 540 *32,800	*25 180 *54,550	18 010 38,700	*18 380 *39,800	11 680 25,150	*14 290 *30,950	8460 18,200	10 940 23,550	6480 13,950			9390 20,730	5540 12,240	9.92 32.52
-3.0 m -10.0 ft	kg lb	*20 360 *45,950	*20 360 *45,950	*23 930 *51,850	17 980 38,650	*17 880 *38,700	11 560 24,900	*13 940 *30,100	8360 18,000	10 900 23,500	6430 13,850			*10 330 *22,780	6100 13,510	9.31 30.45
-4.5 m -15.0 ft	kg lb	*23 890 *53,300	*23 890 *53,300	*21 350 *46,050	18 220 39,200	*16 240 *34,950	11 670 25,150	*12 570 *26,900	8440 18,200					*10 430 *22,990	7210 16,060	8.38 27.33
-6.0 m -20.0 ft	kg lb	*22 500 *47,900	*22 500 *47,900	*16 910 *36,000	*16 910 *36,000	*12 850 *27,100	12 020 25,950							*10 120 *22,190	9590 21,690	7.03 22.69

* Limited to hydraulic capacity rather than tipping load. The above loads are in compliance with hydraulic excavator lift capacity rating standard ISO 10567. They do not exceed 87% of hydraulic lifting capacity or 75% of tipping capacity. All lifts with heavy lift on. Always refer to the appropriate Operation and Maintenance Manual for specific product information.

HD Reach Boom Lift Capacities



Load Point Height



Load Radius Over Front



Load Radius Over Side



Load at Maximum Reach – Bucket Curled



Load at Maximum Reach

BOOM – 6.9 m (22'8")
STICK – 3.35 m (11'0")

BUCKET – GP-C 2.36 yd³ – 1820 kg (4,013 lb)
SHOES – 900 mm (36") triple grouser

UNDERCARRIAGE – Long – fixed gauge
COUNTERWEIGHT – 9000 kg (19,842 lb)

Diagram	3.0 m/10.0 ft		4.5 m/15.0 ft		6.0 m/20.0 ft		7.5 m/25.0 ft		9.0 m/30.0 ft		Diagram		Diagram				
	Diagram	Diagram	Diagram	Diagram	Diagram	Diagram	Diagram	Diagram	Diagram	Diagram	Diagram	m ft	Diagram	Diagram	m ft		
9.0 m 30.0 ft	kg lb											*7490 *16,700	*7490 *16,700	6.28 20.14	*4630 *10,250	*4630 *10,250	9.44 30.60
7.5 m 25.0 ft	kg lb											*6980 *15,450	*6980 *15,450	7.44 24.16	*4460 *9,850	*4460 *9,850	10.44 34.03
6.0 m 20.0 ft	kg lb							*9600 *20,900	*9600 *20,900	*8900 *19,500	6970 14,900	*6840 *15,090	6120 13,620	8.21 26.82	*4450 *9,800	*4450 *9,800	11.08 36.24
4.5 m 15.0 ft	kg lb					*12 600 *27,200	*12 600 *27,200					*6960 *15,330	5390 11,950	8.69 28.47	*4560 *10,050	4270 9,450	11.44 37.50
3.0 m 10.0 ft	kg lb			*20 620 *44,300	19 980 43,150	*14 740 *31,800	12 800 27,600	*11 780 *25,500	8950 19,250	*10 020 *21,750	6540 14,000	*7320 *16,110	5010 11,060	8.92 29.27	*4790 *10,550	4060 8,950	11.56 37.92
1.5 m 5.0 ft	kg lb			*23 140 *51,000	18 280 39,400	*16 540 *35,750	11 930 25,700	*12 840 *27,800	8470 18,200	*10 610 *23,000	6270 13,450	*7960 *17,510	4880 10,770	8.92 29.28	*5170 *11,400	4050 8,900	11.44 37.56
Ground Line	kg lb			*21 560 *50,150	17 490 37,650	*17 550 *38,000	11 340 24,400	*13 520 *29,250	8100 17,400	10 550 22,650	6050 13,000	5970 19,700	5000 11,030	8.69 28.52	*5740 *12,650	4240 9,350	11.09 36.38
-1.5 m -5.0 ft	kg lb	*13 540 *30,600	*13 540 *30,600	*23 970 *52,000	17 290 37,150	*17 640 *38,200	11 060 23,800	*13 630 *29,500	7890 16,950	10 420 22,400	5940 12,750	9660 21,330	5420 11,970	8.22 26.92	*6600 *14,600	4690 10,350	10.47 34.29
-3.0 m -10.0 ft	kg lb	*20 690 *46,750	*20 690 *46,750	*22 230 *48,150	17 430 37,450	*16 750 *36,200	11 040 23,750	*12 960 *27,950	7860 16,900	*9910 21,750	5970 12,750	*9780 *21,560	6300 13,970	7.45 24.35	*7950 *17,500	5600 12,400	9.52 31.10
-4.5 m -15.0 ft	kg lb	*22 980 *51,200	*22 980 *51,200	*19 130 *41,200	17 830 38,350	*14 620 *31,350	11 250 24,250	*11 010 *23,300	8040 17,350			*9440 *20,720	8110 18,160	6.32 20.51			
-6.0 m -20.0 ft	kg lb			*13 850 *29,150	*13 850 *29,150	*10 210 *20,950	*10 210 *20,950										

* Limited to hydraulic capacity rather than tipping load. The above loads are in compliance with hydraulic excavator lift capacity rating standard ISO 10567. They do not exceed 87% of hydraulic lifting capacity or 75% of tipping capacity. All lifts with heavy lift on.



Load Point Height



Load Radius Over Front



Load Radius Over Side



Load at Maximum Reach

BOOM – 6.9 m (22'8")
STICK – 3.35 m (11'0")

BUCKET – Bare coupler – 934 kg (2,059 lb)
SHOES – 900 mm (36") triple grouser

UNDERCARRIAGE – Long – fixed gauge
COUNTERWEIGHT – 9000 kg (19,842 lb)

Diagram	3.0 m/10.0 ft		4.5 m/15.0 ft		6.0 m/20.0 ft		7.5 m/25.0 ft		9.0 m/30.0 ft		Diagram		Diagram	
	Diagram	Diagram	Diagram	Diagram	Diagram	Diagram	Diagram	Diagram	Diagram	Diagram	Diagram	m ft	Diagram	Diagram
9.0 m 30.0 ft	kg lb											*18,260	*18,260	23.67
7.5 m 25.0 ft	kg lb											*7680 *17,110	*7680 *17,110	8.46 27.48
6.0 m 20.0 ft	kg lb							*10 170 *22,200	*10 170 *22,200	*9530 *20,900	7490 16,050	*7550 *16,760	6870 15,310	9.22 30.09
4.5 m 15.0 ft	kg lb					*13 140 *28,400	*13 140 *28,400	*11 180 *24,300	9910 21,350	*10 000 *21,800	7300 15,650	*7640 *16,960	6130 13,600	9.71 31.79
3.0 m 10.0 ft	kg lb			*21 210 *45,600	20 430 44,100	*15 310 *33,050	13 240 28,550	*12 360 *26,800	9420 20,300	*10 630 *23,100	7030 15,100	*7960 *17,660	5720 12,640	9.98 32.71
1.5 m 5.0 ft	kg lb			*24 040 *52,500	18 870 40,650	*17 160 *37,100	12 420 26,800	*13 440 *29,100	8950 19,300	*11 210 *24,250	6770 14,550	*8520 *18,920	5550 12,240	10.03 32.90
Ground Line	kg lb			*22 350 *51,900	18 140 39,050	*18 200 *39,400	11 870 25,550	*14 130 *30,600	8600 18,500	11 030 23,750	6560 14,100	*9410 *20,920	5600 12,360	9.87 32.37
-1.5 m -5.0 ft	kg lb	*14 120 *31,900	*14 120 *31,900	*24 730 *53,650	17 940 38,550	*18 300 *39,650	11 600 25,000	*14 250 *30,850	8400 18,100	10 910 23,500	6440 13,900	10 030 22,160	5910 13,070	9.49 31.08
-3.0 m -10.0 ft	kg lb	*21 130 *46,900	*21 130 *46,900	*22 960 *49,750	18 040 38,800	*17 400 *37,650	11 570 24,900	*13 580 *29,300	8360 18,000	*10 520 23,100	6470 14,250	*10 590 *23,370	6600 14,630	8.84 28.90
-4.5 m -15.0 ft	kg lb	*23 430 *52,350	*23 430 *52,350	*19 810 *42,700	18 390 39,550	*15 250 *32,750	11 760 25,350	*11 610 *24,600	8530 18,450			*10 440 *23,020	7980 17,820	7.86 25.60
-6.0 m -20.0 ft	kg lb			*14 460 *30,450	*14 460 *30,450	*10 790 *22,250	*10 790 *22,250					*9510 *20,750	*9510 *20,750	6.39 20.56

* Limited to hydraulic capacity rather than tipping load. The above loads are in compliance with hydraulic excavator lift capacity rating standard ISO 10567. They do not exceed 87% of hydraulic lifting capacity or 75% of tipping capacity. All lifts with heavy lift on. Always refer to the appropriate Operation and Maintenance Manual for specific product information.

HD Reach Boom Lift Capacities



Load Point Height



Load Radius Over Front



Load Radius Over Side



Load at Maximum Reach – Bucket Curled



















Load at Maximum Reach

BOOM – 6.9 m (22'8")
STICK – 3.9 m (12'10")

BUCKET – GP-C 2.36 yd³ – 1820 kg (4,013 lb)
SHOES – 900 mm (36") triple grouser

UNDERCARRIAGE – Long – fixed gauge
COUNTERWEIGHT – 7641 kg (16,846 lb)

	4.5 m/15.0 ft		6.0 m/20.0 ft		7.5 m/25.0 ft		9.0 m/30.0 ft		10.5 m/35.0 ft									
													m ft			m ft		
9.0 m 30.0 ft	kg lb												*6460 *14,360	*6460 *14,360	6.83 21.99	*4230 *9,350	*4230 *9,350	9.97 32.33
7.5 m 25.0 ft	kg lb						*7540 *14,950	6580 14,000					*6110 *13,500	*6110 *13,500	7.92 25.75	*4110 *9,050	*4110 *9,050	10.90 35.56
6.0 m 20.0 ft	kg lb						*8370 *18,300	6510 13,900					*6050 *13,330	5110 11,390	8.65 28.27	*4130 *9,100	3950 8,750	11.51 37.66
4.5 m 15.0 ft	kg lb					*10 000 *21,700	8850 19,000	*8940 *19,450	6290 13,450	*6640 4530			*6190 *13,630	4500 9,970	9.11 29.85	*4260 *9,350	3570 7,900	11.86 38.86
3.0 m 10.0 ft	kg lb	*19 080 *41,000	*19 080 *41,000	*13 930 *30,050	12 050 25,950	*11 260 *24,400	8320 17,900	*9650 *20,950	6010 12,850	7850 *16,400	4400 9,350	*6550 *14,400	4160 9,190	9.33 30.61	*4500 *9,900	3370 7,450	11.97 39.27	
1.5 m 5.0 ft	kg lb	*22 710 *48,950	17 200 37,050	*15 960 *34,500	11 100 23,900	*12 450 *26,950	7800 16,750	10 050 21,550	5710 12,250	7680 16,450	4250 9,050	*7140 *15,720	4030 8,880	9.33 30.63	*4880 *10,750	3340 7,350	11.86 38.91	
Ground Line	kg lb	*24 410 *52,800	16 130 34,700	*17 290 *37,400	10 410 22,400	*13 160 *28,250	7370 15,850	9770 21,000	5450 11,700	7540 16,200	4120 8,800	7650 16,860	4100 9,040	9.11 29.9	*5450 *12,000	3470 7,650	11.52 37.78	
-1.5 m -5.0 ft	kg lb	*24 450 *53,000	15 720 33,750	*17 740 *38,400	10 030 21,550	12 850 27,600	7100 15,250	9590 20,600	5290 11,350			8200 18,100	4400 9,730	8.66 28.37	*6300 *13,900	3810 8,400	10.92 35.80	
-3.0 m -10.0 ft	kg lb	*23 220 *50,250	15 710 33,750	*17 230 *37,250	9910 21,300	12 740 27,400	7000 15,050	9540 20,550	5250 11,300			9320 20,660	5060 11,200	7.93 25.92	*7650 *17,000	4490 9,950	10.03 32.78	
-4.5 m -15.0 ft	kg lb	*20 670 *44,600	15 990 34,350	*15 610 *33,600	10 030 21,600	*11 960 *25,550	7100 15,300					*9590 *21,120	6370 14,240	6.86 22.32				
-6.0 m -20.0 ft	kg lb	*16 280 *34,600	*16 280 *34,600	*12 250 *25,800	10 420 22,500							*8900 *19,410	*8900 *19,410	5.30 16.96				

* Limited to hydraulic capacity rather than tipping load. The above loads are in compliance with hydraulic excavator lift capacity rating standard ISO 10567. They do not exceed 87% of hydraulic lifting capacity or 75% of tipping capacity. All lifts with heavy lift on.



Load Point Height



Load Radius Over Front



Load Radius Over Side

















Load at Maximum Reach

BOOM – 6.9 m (22'8")
STICK – 3.9 m (12'10")

BUCKET – Bare coupler – 934 kg (2,059 lb)
SHOES – 900 mm (36") triple grouser

UNDERCARRIAGE – Long – fixed gauge
COUNTERWEIGHT – 7641 kg (16,846 lb)

	3.0 m/10.0 ft		4.5 m/15.0 ft		6.0 m/20.0 ft		7.5 m/25.0 ft		9.0 m/30.0 ft		10.5 m/35.0 ft					
														m ft		
9.0 m 30.0 ft	kg lb													*15,830 *15,830	25.47	
7.5 m 25.0 ft	kg lb								*8070 *16,150	7120 15,200				*6800 *15,030	*6800 *15,030	8.93 29.06
6.0 m 20.0 ft	kg lb								*8990 *19,700	7020 15,050				*6730 14,840	5860 13,030	9.66 31.56
4.5 m 15.0 ft	kg lb						*10 570 *22,950	9310 20,000	*9550 *20,800	6800 14,600				*6860 *15,100	5230 11,580	10.13 33.19
3.0 m 10.0 ft	kg lb			*19 630 *42,200	19 500 42,100	*14 480 *31,300	12 470 26,900	*11 840 *25,650	8790 18,900	*10 260 *22,300	6500 13,950	8370 *17,400	4930 10,550	*7170 *15,770	4860 10,740	10.39 34.08
1.5 m 5.0 ft	kg lb			*23 360 *50,400	17 720 38,200	*16 560 *35,800	11 570 24,950	*13 050 *28,300	8280 17,850	10 530 22,650	6210 13,350	8200 17,600	4770 10,250	*7690 *16,930	4700 10,360	10.44 34.26
Ground Line	kg lb	*9780 *22,200	*9780 *22,200	*25 120 *54,350	16 720 35,950	*17 930 *38,800	10 920 23,500	13 640 29,300	7870 16,950	10 260 22,050	5960 12,800	8060 17,300	4640 9,950	8220 18,130	4720 10,400	10.29 33.76
-1.5 m -5.0 ft	kg lb	*14 540 *32,800	*14 540 *32,800	*25 180 *54,550	16 330 35,100	*18 380 *39,800	10 560 22,750	13 340 28,700	7610 16,400	10 080 21,700	5800 12,500			8640 19,060	4940 10,910	9.92 32.52
-3.0 m -10.0 ft	kg lb	*20 360 *45,950	*20 360 *45,950	*23 930 *51,850	16 300 35,050	*17 880 *38,700	10 440 22,500	13 230 28,450	7510 16,200	10 040 21,600	5760 12,400			9520 21,070	5450 12,080	9.31 30.45
-4.5 m -15.0 ft	kg lb	*23 890 *53,300	*23 890 *53,300	*21 350 *46,050	16 540 35,550	*16 240 *34,950	10 540 22,700	*12 570 *26,900	7590 16,400					*10,430 *22,990	6470 14,420	8.38 27.33
-6.0 m -20.0 ft	kg lb	*22 500 *47,900	*22 500 *47,900	*16 910 *36,000	*16 910 *36,000	*12 850 *27,100	10 900 23,550							*10,120 *22,190	8680 19,630	7.03 22.69

* Limited to hydraulic capacity rather than tipping load. The above loads are in compliance with hydraulic excavator lift capacity rating standard ISO 10567. They do not exceed 87% of hydraulic lifting capacity or 75% of tipping capacity. All lifts with heavy lift on. Always refer to the appropriate Operation and Maintenance Manual for specific product information.

HD Reach Boom Lift Capacities



Load Point Height



Load Radius Over Front



Load Radius Over Side



Load at Maximum Reach - Bucket Curled



Load at Maximum Reach

BOOM – 6.9 m (22'8")
STICK – 3.9 m (12'10")

BUCKET – GP-C 2.36 yd³ – 1820 kg (4,013 lb)
SHOES – 900 mm (36") triple grouser

UNDERCARRIAGE – Long – variable gauge
COUNTERWEIGHT – 9000 kg (19,842 lb)

Diagram	4.5 m/15.0 ft		6.0 m/20.0 ft		7.5 m/25.0 ft		9.0 m/30.0 ft		10.5 m/35.0 ft		Diagram		Diagram		m ft		
	Diagram	Diagram	Diagram	Diagram	Diagram	Diagram	Diagram	Diagram	Diagram	Diagram	Diagram	Diagram	Diagram	Diagram	Diagram	Diagram	Diagram
9.0 m 30.0 ft	kg lb											*6410 *14,240	*6410 *14,240	6.96 22.41	*4210 *9,350	*4210 *9,350	10.07 32.70
7.5 m 25.0 ft	kg lb						*7800 *15,650	*7800 *15,650				*6090 *13,460	*6090 *13,460	8.00 26.03	*4110 *9,050	*4110 *9,050	10.97 35.80
6.0 m 20.0 ft	kg lb						*8410 *18,400	7940 17,000				*6050 *13,330	*6050 *13,330	8.71 28.46	*4140 *9,100	*4140 *9,100	11.55 37.81
4.5 m 15.0 ft	kg lb					*10 120 *21,950	*10 120 *21,950	*9010 *19,600	7710 16,550	*6860 *12,450	5710 12,150	*6220 *13,680	5680 12,580	9.14 29.95	*4280 *9,400	*4280 *9,400	11.88 38.93
3.0 m 10.0 ft	kg lb	*19 500 *41,900	*19 500 *41,900	*14 140 *30,500	*14 140 *30,500	*11 380 *24,650	10 100 21,750	*9720 *21,100	7420 15,900	*8630 *16,700	5570 11,900	*6590 *14,500	5330 11,770	9.34 30.65	*4530 *9,950	4370 9,650	11.97 39.27
1.5 m 5.0 ft	kg lb	*22 970 *49,550	20 980 45,150	*16 130 *34,850	13 520 29,100	*12 560 *27,200	9580 20,600	*10 410 *22,550	7120 15,300	8750 *18,450	5420 11,600	*7210 *15,880	5220 11,510	9.32 30.59	*4930 *10,850	4370 9,600	11.83 38.84
Ground Line	kg lb	*24 480 *52,950	19 960 42,900	*17 380 *37,600	12 850 27,650	*13 380 *28,950	9160 19,700	*10 880 *23,550	6870 14,750	8610 *16,150	5290 11,350	*8190 *18,050	5350 11,790	9.08 29.79	*5520 *12,150	4550 10,050	11.47 37.63
-1.5 m -5.0 ft	kg lb	*24 390 *52,850	19 580 42,050	*17 730 *38,400	12 480 26,850	*13 670 *29,600	8910 19,150	10 890 23,400	6710 14,450			*9430 *20,800	5760 12,710	8.60 28.18	*6400 *14,150	5000 11,050	10.85 35.56
-3.0 m -10.0 ft	kg lb	*23 030 *49,850	19 610 42,100	*17 130 *37,050	12 390 26,650	*13 240 *28,550	8820 19,000	*10 360 *22,200	6690 14,400			*9610 *21,200	6590 14,620	7.84 25.64	*7830 *17,400	5860 13,000	9.92 32.43
-4.5 m -15.0 ft	kg lb	*20 340 *43,850	19 930 42,800	*15 380 *33,050	12 540 27,000	*11 740 *25,050	8940 19,250					*9570 *21,070	8270 18,500	6.74 21.90			
-6.0 m -20.0 ft	kg lb	*15 710 *33,350	*15 710 *33,350	*11 780 *24,700	*11 780 *24,700							*8750 *19,030	*8750 *19,030	5.10 16.31			

* Limited to hydraulic capacity rather than tipping load. The above loads are in compliance with hydraulic excavator lift capacity rating standard ISO 10567. They do not exceed 87% of hydraulic lifting capacity or 75% of tipping capacity. All lifts with heavy lift on.



Load Point Height



Load Radius Over Front



Load Radius Over Side



Load at Maximum Reach - Bucket Curled



Load at Maximum Reach

BOOM – 6.9 m (22'8")
STICK – 3.35 m (11'0")

BUCKET – GP-C 2.36 yd³ – 1820 kg (4,013 lb)
SHOES – 900 mm (36") triple grouser

UNDERCARRIAGE – Long – variable gauge
COUNTERWEIGHT – 9000 kg (19,842 lb)

Diagram	3.0 m/10.0 ft		4.5 m/15.0 ft		6.0 m/20.0 ft		7.5 m/25.0 ft		9.0 m/30.0 ft		Diagram		Diagram		m ft		
	Diagram	Diagram	Diagram	Diagram	Diagram	Diagram	Diagram	Diagram	Diagram	Diagram	Diagram	Diagram	Diagram	Diagram	Diagram	Diagram	Diagram
9.0 m 30.0 ft	kg lb														*4600 *10,200	*4600 *10,200	9.56 30.99
7.5 m 25.0 ft	kg lb									*6860 *15,380	*6860 *15,380	*6960 *15,380	*6960 *15,380	7.53 24.46	*4450 *9,850	*4450 *9,850	10.51 34.29
6.0 m 20.0 ft	kg lb							*9680 *21,050	*9680 *21,050	*8940 *19,550	7730 16,550	*6850 *15,090	6750 15,020	8.27 27.01	*4450 *9,800	*4450 *9,800	11.12 36.40
4.5 m 15.0 ft	kg lb					*12 810 *27,650	*12 810 *27,650	*10 720 *23,250	10 400 22,350	*9450 *20,550	7540 16,150	*6990 *15,380	6020 13,340	8.73 28.58	*4580 *10,050	*4580 *10,050	11.46 37.57
3.0 m 10.0 ft	kg lb			*21 000 *45,100	*21 000 *45,100	*14 940 *32,250	14 090 30,400	*11 890 *25,750	9890 21,300	*10 080 *21,900	7270 15,600	*7370 *16,210	5650 12,460	8.93 29.30	*4820 *10,600	4600 10,150	11.56 37.92
1.5 m 5.0 ft	kg lb			*22 450 *51,350	20 390 43,900	*16 680 *36,050	13 230 28,500	*12 920 *27,950	9410 20,250	*10 650 *23,100	7010 15,050	*8030 *17,680	5540 12,220	8.91 29.24	*5220 *11,500	4620 10,150	11.42 37.48
Ground Line	kg lb	*7750 *17,700	*7750 *17,700	*21 830 *50,650	19 660 42,250	*17 600 *38,100	12 660 27,250	*13 560 *29,350	9050 19,450	*10 970 *23,600	6800 14,600	*9110 *20,080	5710 12,590	8.66 28.40	*5810 *12,800	4850 10,700	11.04 36.22
-1.5 m -5.0 ft	kg lb	*14 180 *32,000	*14 180 *32,000	*23 860 *51,750	19 490 41,850	*17 600 *38,100	12 400 26,700	*13 610 *29,400	8850 19,050	*10 820 *23,300	6690 14,400	*9760 *21,530	6210 13,720	8.15 26.72	*6710 *14,850	5390 11,900	10.39 34.04
-3.0 m -10.0 ft	kg lb	*21 350 *47,300	*21 350 *47,300	*22 000 *47,650	19 660 42,250	*16 610 *35,900	12 400 26,700	*12 840 *27,650	8840 19,050	*9730 *21,530	6740 14,400	*9770 *21,530	7240 16,070	7.36 24.05	*7900 *17,400	6440 14,300	9.40 30.73
-4.5 m -15.0 ft	kg lb	*23 240 *51,850	*23 240 *51,850	*18 730 *40,350	*18 730 *40,350	*14 330 *30,700	12 650 27,250	*10 700 *22,550	9050 19,550			*9360 *20,550	*9360 *20,550	6.18 20.06			
-6.0 m -20.0 ft	kg lb			*13 150 *28,950	*13 150 *28,950	*9530 *21,000	*9530 *21,000										

* Limited to hydraulic capacity rather than tipping load. The above loads are in compliance with hydraulic excavator lift capacity rating standard ISO 10567. They do not exceed 87% of hydraulic lifting capacity or 75% of tipping capacity. All lifts with heavy lift on.

Always refer to the appropriate Operation and Maintenance Manual for specific product information.

HD Reach Boom Lift Capacities



Load Point Height



Load Radius Over Front



Load Radius Over Side



Load at Maximum Reach - Bucket Curled



















Load at Maximum Reach

BOOM – 6.9 m (22'8")
STICK – 3.9 m (12'10")

BUCKET – GP-C 2.36 yd³ – 1820 kg (4,013 lb)
SHOES – 900 mm (36") triple grouser

UNDERCARRIAGE – Long – wide variable gauge
COUNTERWEIGHT – 9000 kg (19,842 lb)

	4.5 m/15.0 ft		6.0 m/20.0 ft		7.5 m/25.0 ft		9.0 m/30.0 ft		10.5 m/35.0 ft									
													m ft			m ft		
9.0 m 30.0 ft	kg lb												*6410 *14,240	*6410 *14,240	6.96 22.41	*4210 *9,350	*4210 *9,350	10.07 32.7
7.5 m 25.0 ft	kg lb						*7800 *15,650	*7800 *15,650					*6100 *13,460	*6100 *13,460	8.00 26.03	*4110 *9,050	*4110 *9,050	10.97 35.80
6.0 m 20.0 ft	kg lb						*8410 *18,400	*8410 *18,400					*6050 *13,330	*6050 *13,330	8.71 28.46	*4140 *9,100	*4140 *9,100	11.55 37.81
4.5 m 15.0 ft	kg lb					*10 120 *21,950	*10 120 *21,950	*9010 *19,600	8940 19,200	*6860 *12,450	6680 *12,450		*6220 *13,680	*6220 *13,680	9.14 29.95	*4280 *9,400	*4280 *9,400	11.88 38.93
3.0 m 10.0 ft	kg lb	*19 500 *41,900	*19 500 *41,900	*14 140 *30,500	*14 140 *30,500	*11 380 *24,650	*11 380 *24,650	*9720 *21,100	8640 18,550	*8630 *16,700	6550 14,000	*6590 *14,500	6310 13,920	9.34 30.65	*4530 *9,950	*4530 *9,950	11.97 39.27	
1.5 m 5.0 ft	kg lb	*22 970 *49,550	*22 970 *49,550	*16 130 *34,850	15 840 34,100	*12 560 *27,200	11 180 24,050	*10 410 *22,550	8330 17,900	8900 *18,450	6390 13,700	*7210 *15,880	6200 13,670	9.32 30.59	*4930 *10,850	*4930 *10,850	11.83 38.84	
Ground Line	kg lb	*24 480 *52,850	23 950 50,500	*17 380 *37,600	15 140 32,600	*13 380 *28,950	10 750 23,150	*10 880 *23,550	8080 17,350	8760 *16,150	6260 13,450	*8190 *18,050	6350 14,010	9.08 29.79	*5520 *12,150	5410 11,950	11.47 37.63	
-1.5 m -5.0 ft	kg lb	*24 390 *52,850	23 550 50,500	*17 730 *38,400	14 770 31,750	*13 670 *29,600	10 490 22,550	*10 950 *23,650	7920 17,000			*9430 *20,800	6830 15,090	8.60 28.18	*6400 *14,150	5920 13,100	10.85 35.56	
-3.0 m -10.0 ft	kg lb	*23 030 *49,850	*23 030 *49,850	*17 130 *37,050	14 670 31,550	*13 240 *28,550	10 400 22,400	*10 360 *22,200	7890 17,000			*9610 *21,200	7800 17,300	7.84 25.64	*7830 *17,400	6910 15,300	9.92 32.43	
-4.5 m -15.0 ft	kg lb	*20 340 *43,850	*20 340 *43,850	*15 380 *33,050	14 820 31,900	*11 740 *25,050	10 520 22,650					*9570 *21,070	*9570 *21,070	6.74 21.9				
-6.0 m -20.0 ft	kg lb	*15 710 *33,350	*15 710 *33,350	*11 780 *24,700	*11 780 *24,700							*8750 *19,030	*8750 *19,030	5.10 16.31				

* Limited to hydraulic capacity rather than tipping load. The above loads are in compliance with hydraulic excavator lift capacity rating standard ISO 10567. They do not exceed 87% of hydraulic lifting capacity or 75% of tipping capacity. All lifts with heavy lift on. Always refer to the appropriate Operation and Maintenance Manual for specific product information.

Mass Boom Lift Capacities



Load Point Height



Load Radius Over Front



Load Radius Over Side



Load at Maximum Reach - Bucket Curled



Load at Maximum Reach

BOOM – 6.55 m (21'6")
STICK – 2.5 m (8'2")

BUCKET – UB 75 HDR V-edge – 3062 kg (6,752 lb)
SHOES – 900 mm (36") triple grouser

UNDERCARRIAGE – Long – fixed gauge
COUNTERWEIGHT – 9000 kg (19,842 lb)

Load Point Height	3.0 m/10.0 ft		4.5 m/15.0 ft		6.0 m/20.0 ft		7.5 m/25.0 ft		9.0 m/30.0 ft		Load at Maximum Reach - Bucket Curled			Load at Maximum Reach			
	kg	lb	kg	lb	kg	lb	kg	lb	kg	lb	kg	lb	m	kg	lb	m	
9.0 m 30.0 ft														*5940	*5940	7.95	
7.5 m 25.0 ft													*10 140	9020	5.92	*5600	
6.0 m 20.0 ft							*9850	8520					*22,480	20,460	19.11	*12,350	*5600
4.5 m 15.0 ft							*21,450	18,150					*9740	6790	6.85	*5540	4770
3.0 m 10.0 ft													*21,500	15,190	22.32	*12,200	10,650
1.5 m 5.0 ft													*9630	5660	7.41	*5680	4140
Ground Line													*21,230	12,550	24.26	*12,500	9,200
-1.5 m -5.0 ft	*16 420	*16 420	*21 650	16 450	*16 160	10 220	*12 220	7050					*9950	5840	6.85	*7840	4920
-3.0 m -10.0 ft	*23 670	*23 670	*18 960	16 850	*14 360	10 380	*10 360	7200					*21,940	12,910	22.45	*17,250	10,900
-4.5 m -15.0 ft	*52,100	*52,100	*41,050	36,150	*30,900	22,300							*9640	7440	5.94		
													*21,200	16,570	19.35		
													*8100	*8100	4.49		
													*19,220	*19,220	13.75		

* Limited to hydraulic capacity rather than tipping load. The above loads are in compliance with hydraulic excavator lift capacity rating standard ISO 10567. They do not exceed 87% of hydraulic lifting capacity or 75% of tipping capacity. All lifts with heavy lift on.



Load Point Height



Load Radius Over Front



Load Radius Over Side



Load at Maximum Reach - Bucket Curled



Load at Maximum Reach

BOOM – 6.55 m (21'6")
STICK – 3.0 m (9'10")

BUCKET – UB 75 HDR V-edge – 3062 kg (6,752 lb)
SHOES – 900 mm (36") triple grouser

UNDERCARRIAGE – Long – fixed gauge
COUNTERWEIGHT – 9000 kg (19,842 lb)

Load Point Height	3.0 m/10.0 ft		4.5 m/15.0 ft		6.0 m/20.0 ft		7.5 m/25.0 ft		9.0 m/30.0 ft		Load at Maximum Reach - Bucket Curled			Load at Maximum Reach		
	kg	lb	kg	lb	kg	lb	kg	lb	kg	lb	kg	lb	m	kg	lb	m
9.0 m 30.0 ft														*4420	*4420	8.58
7.5 m 25.0 ft														*9,850	*9,850	27.70
6.0 m 20.0 ft														*7330	*7330	6.48
4.5 m 15.0 ft														*16,250	*16,250	20.98
3.0 m 10.0 ft														*7070	5960	7.35
1.5 m 5.0 ft														*15,590	13,330	23.97
Ground Line														*9,050	*9,050	34.18
-1.5 m -5.0 ft	*15 550	*15 550	*22 350	16 310	*16 310	10 090	*12 310	6910						*7180	5000	7.88
-3.0 m -10.0 ft	*35,250	*35,250	*48,450	35,000	*35,250	21,650	*26,550	14,800						*15,790	11,100	25.80
-4.5 m -15.0 ft														*9,250	8,200	35.58
														*20,000	11,450	26.68
														*16,730	9,960	26.68
														*9,960	9,960	26.68
														*8420	4340	8.14
														*18,520	9,580	26.70
														*10,850	7,550	35.65
														*4920	3420	10.86
														*5610	3660	10.47
														*12,350	8,050	34.34
														*9270	5060	7.35
														*20,430	11,180	24.09
														*9180	6290	6.51
														*20,200	14,000	21.21
														*8360	*8360	5.18
														*18,260	*18,260	16.74

* Limited to hydraulic capacity rather than tipping load. The above loads are in compliance with hydraulic excavator lift capacity rating standard ISO 10567. They do not exceed 87% of hydraulic lifting capacity or 75% of tipping capacity. All lifts with heavy lift on. Always refer to the appropriate Operation and Maintenance Manual for specific product information.

Long Reach Boom Lift Capacities



Load Point Height



Load Radius Over Front



Load Radius Over Side



Load at Maximum Reach – Bucket Curled



Load at Maximum Reach

BOOM – 7.4 m (24'3")
STICK – 4.3 m (14'1")

BUCKET – GP-C 2.36 yd³ – 1820 kg (4,013 lb)
SHOES – 900 mm (36") triple grouser

UNDERCARRIAGE – Long – fixed gauge
COUNTERWEIGHT – 9000 kg (19,842 lb)

	4.5 m/15.0 ft		6.0 m/20.0 ft		7.5 m/25.0 ft		9.0 m/30.0 ft		10.5 m/35.0 ft								
													m ft			m ft	
9.0 m 30.0 ft	kg lb							*6510 *12,850	*6510 *12,850			*5660 *12,550	*5660 *12,550	7.87 25.44	*3850 *8,500	*3850 *8,500	10.95 35.60
7.5 m 25.0 ft	kg lb							*7170 *15,700	*7170 *15,500			*5460 *12,050	*5460 *12,050	8.84 28.79	*3790 *8,350	*3790 *8,350	11.79 38.49
6.0 m 20.0 ft	kg lb							*7600 *16,550	7090 15,200	*7140 *14,250	5120 10,900	*5460 *12,030	4670 10,400	9.51 31.08	*3830 *8,450	3680 8,200	12.34 40.41
4.5 m 15.0 ft	kg lb					*9380 *20,300	*9380 *20,300	*8260 *17,950	6810 14,600	*7520 *16,400	4990 10,650	*5630 *12,390	4160 9,220	9.93 32.54	*3980 *8,750	3350 7,400	12.66 41.52
3.0 m 10.0 ft	kg lb	*18 670 *40,050	*18 670 *40,050	*13 400 *28,900	12 810 27,600	*10 680 *23,100	8900 19,150	*9040 *19,600	6470 13,900	*7950 *17,300	4800 10,250	*5970 *13,140	3870 8,550	10.14 33.25	*4220 *9,300	3180 7,000	12.77 41.89
1.5 m 5.0 ft	kg lb	*22 210 *47,850	18 180 39,200	*15 420 *33,300	11 790 25,400	*11 890 *25,750	8320 17,900	*9780 *21,200	6130 13,150	8160 17,500	4600 9,850	*6520 *14,340	3750 8,270	10.14 33.26	*4580 *10,100	3140 6,950	12.67 41.57
Ground Line	kg lb	*18 730 *43,400	17 090 36,750	*16 750 *36,200	11 050 23,800	*12 800 *27,700	7860 16,900	10 300 22,150	5840 12,500	7970 17,100	4430 9,500	7080 15,620	3800 8,380	9.93 32.58	*5110 *11,250	3250 7,150	12.35 40.52
-1.5 m -5.0 ft	kg lb	*20 680 *47,400	16 670 35,800	*17 250 *37,350	10 640 22,900	*13 230 *28,650	7550 16,250	10 080 21,650	5640 12,100	7850 16,850	4320 9,250	7510 16,570	4040 8,920	9.51 31.17	*5870 *13,000	3520 7,750	11.81 38.70
-3.0 m -10.0 ft	kg lb	*22 870 *49,550	16 650 35,750	*16 920 *36,600	10 500 22,600	*13 090 *28,300	7420 15,950	9990 21,450	5550 11,900	7840	4300	8350 18,490	4540 10,060	8.85 28.94	*7050 *15,650	4050 9,000	10.99 35.97
-4.5 m -15.0 ft	kg lb	*20 820 *44,950	16 890 36,300	*15 720 *33,900	10 580 22,750	*12 200 *26,250	7450 16,050	*9480 *20,200	5600 12,050			*8530 *18,800	5490 12,240	7.89 25.71			
-6.0 m -20.0 ft	kg lb	*17 440 *37,350	17 380 *37,350	*13 350 *28,500	10 870 23,400	*10 160 *21,450	7680 16,600					*8310 *18,230	7430 16,790	6.53 21.09			

* Limited to hydraulic capacity rather than tipping load. The above loads are in compliance with hydraulic excavator lift capacity rating standard ISO 10567. They do not exceed 87% of hydraulic lifting capacity or 75% of tipping capacity. All lifts with heavy lift on.



Load Point Height



Load Radius Over Front



Load Radius Over Side



Load at Maximum Reach – Bucket Curled



Load at Maximum Reach

BOOM – 7.4 m (24'3")
STICK – 3.9 m (12'10")

BUCKET – GP-C 2.36 yd³ – 1820 kg (4,013 lb)
SHOES – 900 mm (36") triple grouser

UNDERCARRIAGE – Long – fixed gauge
COUNTERWEIGHT – 9000 kg (19,842 lb)

	4.5 m/15.0 ft		6.0 m/20.0 ft		7.5 m/25.0 ft		9.0 m/30.0 ft		10.5 m/35.0 ft								
													m ft			m ft	
9.0 m 30.0 ft	kg lb											*6680 *14,820	*6680 *14,820	7.40 23.91	*4610 *10,200	*4610 *10,200	10.54 34.25
7.5 m 25.0 ft	kg lb							*7760 *17,050	7260 15,500			*6440 *14,220	6090 13,640	8.43 27.43	*4530 *10,000	*4530 *10,000	11.42 37.27
6.0 m 20.0 ft	kg lb							*8150 *17,800	7120 15,250			*6450 *14,200	5160 11,470	9.13 29.82	*4580 *10,100	3980 8,850	12.00 39.26
4.5 m 15.0 ft	kg lb					*10 020 *21,700	9490 20,400	*8790 *19,100	6870 14,750	*7980 *17,400	5070 10,800	*6650 *14,630	4600 10,180	9.56 31.33	*4740 *10,400	3630 8,050	12.33 40.40
3.0 m 10.0 ft	kg lb	*20 080 *43,100	19 830 42,800	*14 240 *30,700	12 740 27,450	*11 290 *24,400	8930 19,250	*9530 *20,650	6550 14,050	*8370 *18,150	4900 10,500	*7060 *15,530	4280 9,460	9.78 32.06	*5010 *11,000	3450 7,600	12.43 40.79
1.5 m 5.0 ft	kg lb	*19 350 *46,100	18 030 38,900	*16 130 *34,800	11 800 25,450	*12 430 *26,900	8400 18,100	*10 210 *22,150	6240 13,400	8280 17,750	4730 10,100	7520 16,570	4160 9,180	9.78 32.08	*5420 *11,900	3420 7,550	12.33 40.45
Ground Line	kg lb	*17 660 *40,900	17 180 36,950	*17 260 *37,300	11 160 24,050	*13 230 *28,600	7990 17,200	10 440 22,450	5980 12,850	8120 17,450	4580 9,800	7670 16,910	4230 9,320	9.56 31.37	*6010 *13,250	3540 7,800	12.00 39.37
-1.5 m -5.0 ft	kg lb	*20 910 *47,900	16 930 36,350	*17 530 *37,950	10 840 23,300	*13 520 *29,250	7730 16,650	10 250 22,050	5810 12,500	8030 17,250	4500 9,650	8160 18,020	4510 9,960	9.13 29.92	*6880 *15,200	3860 8,550	11.44 37.49
-3.0 m -10.0 ft	kg lb	*22 620 *49,900	17 000 36,500	*16 970 *36,700	10 760 23,150	*13 200 *28,500	7640 16,450	10 200 21,950	5760 12,400			*8970 *19,780	5100 11,300	8.44 27.60	*7450 *16,400	4470 9,900	10.59 34.65
-4.5 m -15.0 ft	kg lb	*20 240 *43,700	17 300 37,200	*15 490 *33,400	10 880 23,450	*12 070 *25,900	7720 16,650					*8990 *19,800	6230 13,900	7.44 24.21			
-6.0 m -20.0 ft	kg lb	*16 430 *35,100	*16 430 *35,100	*12 710 *27,000	11 230 24,200	*9510 *19,850	8010 17,300					*8530 *18,650	*8530 *18,650	5.99 19.30			

* Limited to hydraulic capacity rather than tipping load. The above loads are in compliance with hydraulic excavator lift capacity rating standard ISO 10567. They do not exceed 87% of hydraulic lifting capacity or 75% of tipping capacity. All lifts with heavy lift on.

Always refer to the appropriate Operation and Maintenance Manual for specific product information.

Long Reach Boom Lift Capacities



Load Point Height



Load Radius Over Front



Load Radius Over Side



Load at Maximum Reach – Bucket Curled



















Load at Maximum Reach

BOOM – 7.4 m (24'3")
STICK – 4.3 m (14'1")

BUCKET – GP-C 2.36 yd³ – 1820 kg (4,013 lb)
SHOES – 900 mm (36") triple grouser

UNDERCARRIAGE – Long – variable gauge
COUNTERWEIGHT – 9000 kg (19,842 lb)

	4.5 m/15.0 ft		6.0 m/20.0 ft		7.5 m/25.0 ft		9.0 m/30.0 ft		10.5 m/35.0 ft								
													m			m	
9.0 m 30.0 ft	kg lb						*6760 *13,550	*6760 *13,550				*5630 *12,480	*5630 *12,480	7.98 30.81	*3840 *8,500	*3840 *8,500	11.04 35.92
7.5 m 25.0 ft	kg lb						*7200 *15,750	*7200 *15,750				*5450 *12,030	*5450 *12,030	8.92 33.96	*3790 *8,350	*3790 *8,350	11.85 38.71
6.0 m 20.0 ft	kg lb						*7650 *16,700	*7650 *16,700	*7200 *14,700	5740 12,200	*5470 *12,040	5220 11,610	9.56 36.13	*3840 *8,450	*3840 *8,450	12.39 40.55	
4.5 m 15.0 ft	kg lb					*9500 *20,550	*9500 *20,550	*8330 *18,100	7550 16,200	*7560 *16,450	5600 11,950	*5660 *12,440	4710 10,420	9.96 37.51	*4000 *8,800	3820 8,450	12.68 41.58
3.0 m 10.0 ft	kg lb	*19 080 *40,950	*19 080 *40,950	*13 610 *29,350	*13 610 *29,350	*10 800 *23,350	9830 21,150	*9110 *19,750	7200 15,450	*7990 *17,350	5400 11,550	*6010 *13,230	4420 9,760	10.15 38.18	*4250 *9,350	3660 8,050	12.77 41.89
1.5 m 5.0 ft	kg lb	*22 400 *48,400	20 250 43,600	*15 580 *33,650	13 070 28,150	*12 000 *25,950	9250 19,900	*9840 *21,300	6860 14,700	*8410 *18,250	5200 11,150	*6580 *14,490	4320 9,520	10.13 38.17	*4630 *10,200	3640 8,000	12.64 41.50
Ground Line	kg lb	*18 750 *43,350	*18 750 *41,300	*16 830 *36,400	12 350 26,600	*12 860 *27,850	8790 18,900	*10 390 *22,500	6570 14,100	8330 17,900	5040 10,800	*7440 *16,400	4400 9,690	9.90 37.50	*5170 *11,400	3770 8,300	12.31 40.38
-1.5 m -5.0 ft	kg lb	*21 030 *48,150	18 840 40,450	*17 250 *37,350	11 970 25,750	*13 250 *28,650	8500 18,300	10 520 22,600	6380 13,700	8220 17,650	4930 10,600	*7940 *17,530	4690 10,350	9.45 36.11	*5970 *13,200	4100 9,050	11.74 38.48
-3.0 m -10.0 ft	kg lb	*22 720 *49,200	18 840 40,450	*16 850 *36,450	11 840 25,450	*13 040 *28,150	8380 18,050	*10 360 *22,300	6300 13,550			*8440 *18,620	5280 11,690	8.77 33.93	*7170 *15,800	4710 10,450	10.90 35.65
-4.5 m -15.0 ft	kg lb	*20 550 *44,400	19 110 41,050	*15 550 *33,500	11 940 25,700	*12 070 *25,950	8430 18,150	*9330 *19,850	6370 13,750			*8530 *18,790	6390 14,250	7.78 30.77			
-6.0 m -20.0 ft	kg lb	*17 020 *36,400	*17 020 *36,400	*13 030 *27,750	12 260 26,400	*9860 *20,750	8690 18,750					*8250 *18,080	*8250 *18,080	6.37 26.29			

* Limited to hydraulic capacity rather than tipping load. The above loads are in compliance with hydraulic excavator lift capacity rating standard ISO 10567. They do not exceed 87% of hydraulic lifting capacity or 75% of tipping capacity. All lifts with heavy lift on. Always refer to the appropriate Operation and Maintenance Manual for specific product information.

Standard Equipment

Standard equipment may vary. Consult your Caterpillar dealer for details.

Auto-lube ready

Auxiliary hydraulic valve and auxiliary pump drive location

Cab

Air conditioner, heater, defroster with automatic climate control

Ashtray with lighter

Bolt-on FOGS capability

Coat hook

Floor mat

Light, interior

Literature compartment

Monitor

Full graphic color display

Start-up level check (engine oil, coolant, and hydraulic oil)

Polycarbonate side windows

Positive filtered ventilation

Radio, AM/FM with two speakers

Seat belt, retractable

Seat, suspension, heated, with high back and head rest

Skylight, openable, with sunshade

Storage compartment suitable for a lunch box cooler

Windshield wiper and washers (upper and lower)

Counterweight 9000 kg (19,840 lb)

Engine

Cat C13 with ACERT Technology

Electric priming pump

Precleaner

Speed control, automatic

Water separator, fuel

Fine swing control

Fuel-Water separator

Heavy lift mode

High ambient cooling

Hydraulic neutralizer lever for all controls

Lights, working

Boom, both sides

Cab mounted, two

Frame mounted

Mirrors, frame and cab

Product Link PL321SR

S•O•SSM analysis, engine and hydraulic sampling ports

Swing parking brake, automatic

Swivel guard

Track

Guiding guards, idler and center sections

Motor guards, track, heavy duty

Travel alarm

Optional Equipment

Optional equipment may vary. Consult your Caterpillar dealer for details.

Auxiliary controls

- Circuit, hammer
- System, tool control with medium pressure
- System, tool control without medium pressure

Auxiliary hydraulic lines for Booms and Sticks

Booms

- Long Reach 7.4 m (24'3")
- Mass excavation 6.55 m (21'6")
- Reach, Heavy-Duty 6.9 m (22'8")

Buckets (see pages 11, 21, 22 and 23)

Bucket linkage:

- TB family (with lift eye)

- UB family

- Bucket pin adapter kit, for using 345B series buckets

- Bucket sidecutters and tips

Cab

- Camera, rear view
- Mounting, radio, 12V and 24V
- Power supply, 7A – 12V (2)
- Rear window emergency exit
- Straight travel pedal
- Sunscreen
- WAVS ready

Check valves

- Boom lowering
- Stick lowering

Counterweight

- Counterweight 7654 kg (16,760 lb)
- Counterweight 7654 kg (16,760 lb) with counterweight removal for a total weight of 7915 kg (17,450 lb)
- Counterweight 8700 kg (19,180 lb) with counterweight removal for a total weight of 9000 kg (19,840 lb)

Coupler

- Pin grabber type, controls, lines

Engine

- Starting, cold weather (two additional batteries, heavy duty battery cables, ether aid)
- Terminal, jump start

Fan, hydraulic, reversing

Guards

- Falling Object, for cab
- Front windshield
- Guiding, track, full length
- Guiding, track, sprocket end
- Heavy-duty, bottom
- Vandalism protection

Hand Control Pattern Changer

High intensity discharge lights

- HID Long reach boom
- HID HD boom

Machine Security System (MSS)

Sticks

- 2.5 m (8'2") Mass
- 3.0 m (9'10") Mass
- 3.35 m (11'0") HD Reach
- 3.9 m (12'10") Long Reach/HD Reach
- 4.3 m (14'1") Long Reach

Undercarriage

Fixed

Idler, Cast

Track, GLT4

- 600 mm (24") double-grouser shoes
- 750 mm (30") triple-grouser shoes
- 900 mm (36") triple-grouser shoes

Track, PPR2

- 750 mm (30") triple-grouser shoes
- 900 mm (36") triple-grouser shoes

Variable

Wide variable

Notes

345D L Hydraulic Excavator

For more complete information on Cat products, dealer services,
and industry solutions, visit us on the web at www.cat.com

© 2009 Caterpillar
All Rights Reserved
Printed in U.S.A.

Materials and specifications are subject to change without notice.
Featured machines in photos may include additional equipment.
See your Caterpillar dealer for available options.

AEHQ5940-02 (2-09)

NACD

CAT, CATERPILLAR, SAFETY.CAT.COM, their respective logos, ACERT, AccuGrade, ADEM,
K Series, "Caterpillar Yellow" and the POWER EDGE trade dress, as well as corporate and product
identity used herein, are trademarks of Caterpillar and may not be used without permission.

CATERPILLAR[®]